

Interface®

ALOFT



APPROVED PROTOTYPES

Aloft Hotels
Courtyard
Delta Hotels
Element
Fairfield Inn & Suites
Four Points
Marriott Hotels
Residence Inn
Sheraton
TownePlace Suites

WHY INTERFACE HOSPITALITY?

Interface Hospitality is a **MARRIOTT INTERNATIONAL** approved supplier of carpet tile and LVT. We are currently approved on the following prototypes:

- Aloft Hotels
- Courtyard
- Delta Hotels
- Element
- Fairfield Inn & Suites
- Four Points
- Marriott Hotels
- Residence Inn
- Sheraton
- TownePlace Suites



SMART, EFFICIENT, AND BUILT TO LAST

Seamless Installation & Design Flexibility

Interface modular flooring tiles are designed for effortless installation with systems like TacTiles®—our no-glue solution that reduces VOCs and waste. Choose from multiple sizes and patterns to create tailored designs that fit your needs while optimizing material usage.

Cost Efficiency, Built-In

Reduce hidden costs with modular tiles—no roll sizes, no wasteful cuts, and an average of only 3-4% waste compared to broadloom's 14%. Our selective replacement system minimizes disruption, allowing you to replace flooring in stages and save up to 50% on replacement costs.

Durability You Can Count On

Every product is backed by a 15-year warranty, combining innovative features like Intersept® mold protection and Protekt2™ stain resistance for unparalleled longevity. With modular carpet, you're investing in a solution that performs and saves in the long run.



DESIGNED FOR PERFORMANCE AND PEOPLE

Innovative Fibers for Vibrant, Sustainable Style

All Interface carpet tiles are made from 100% solution-dyed nylon—engineered for vibrant, fade-resistant color without the need for water or harmful chemicals in production.

The Power of Integrated Systems

Interface tiles span a variety of sizes and textures, enabling endless creative possibilities. Our modular designs seamlessly integrate with LVT for holistic flooring solutions without transition strips, redefining design flexibility.

Health-Conscious Choices

Our Intersept[®] treatment guarantees mold protection and uses no halogens, heavy metals, or harmful chemicals. It's EPA-approved for safe use, ensuring healthier spaces for your guests and teams.

SUSTAINABILITY & END-OF-LIFE SOLUTIONS

Transparency at Every Step

Sustainability comes standard. With third-party certifications and 99% renewable energy powering our U.S. manufacturing, Interface delivers flooring that's both high-performing and environmentally conscious.

Recycling Made Simple with ReEntry[®]

Through ReEntry[®], we reclaim and recycle used carpet tiles and Sound Choice[™] LVT, keeping valuable materials out of landfills. As North America's only third-party-certified flooring recycling program, we set the benchmark for responsible end-of-life solutions.

Smarter Installations for a Smaller Footprint

TacTiles[®] eliminate the need for adhesives with carpet tiles, cutting installation waste by 90%. Combined with modular flooring's reduced waste profile, this innovation ensures your project leaves a lighter environmental footprint.

CORRIDOR PROTOTYPE ORDER INFORMATION

Carpet tiles **SAVE APPROXIMATELY 18%-20% IN PRODUCT WASTE** verses broadloom, based on prototype layout.



PRODUCT	CONTROL#	ITEM#	COLOR#	SAMPLE#	SIZE	INSTALLATION
A Surreal	PG-005D	328177	190720	267549-099	50 cm x 50 cm	Pattern by Tile
B Duplex	PG-005A	328174	105891 Upper East		50 cm x 50 cm	Pattern by Tile
C Sublet	PG-005B	328175	105879 Upper East		50 cm x 50 cm	Pattern by Tile
D Online	PG-005C	328176	103788 Pepper		25 cm x 1 m	Pattern by Tile
E Online	PG-005F	328179	190718	267549-097	25 cm x 1 m	Pattern by Tile
F Online	PG-005E	328178	190719	267549-098	25 cm x 1 m	Pattern by Tile
G Online (<i>not shown</i>)	PG-005G	328180	192251	267549-215	25 cm x 1 m	Pattern by Tile

**Only included in Elevator Lobbies*

INSTALLATION SPECIFICATIONS	DESCRIPTION
XL2000 PLUS Adhesive	Double stick install

CORRIDOR INSTALLATION PLAN

All quantities are estimates only and are based on plans provided. Site measurements and field verifications are recommended to ensure accuracy. These quantities are not intended to be used for material ordering purposes. Since waste factors may vary by installer, actual ordering quantities are the responsibility of your flooring contractor.



LEGEND

A

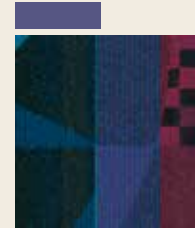

PRODUCT: Surreal M0555
CONTROL: PG-005D
ITEM: 328177
COLOR/SAMPLE: 190720 _267549-099
SIZE: 50 cm x 50 cm
INSTALLED: Pattern by Tile

B

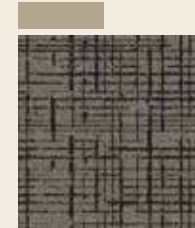

PRODUCT: Duplex
CONTROL: PG-005A
ITEM: 328174
COLOR: 105891 Upper East
SIZE: 50 cm x 50 cm
INSTALLED: Pattern by Tile

C



PRODUCT: Sublet
CONTROL: PG-005B
ITEM: 328175
COLOR: 105879 Upper East
SIZE: 50 cm x 50 cm
INSTALLED: Pattern by Tile

D



PRODUCT: Online
CONTROL: PG-005C
ITEM: 328176
COLOR: 103788 Pepper
SIZE: 25 cm x 1 m
INSTALLED: Pattern by Tile

E



PRODUCT: Online
CONTROL: PG-005F
ITEM: 328179
COLOR/SAMPLE: 190718 _267549-097
SIZE: 25 cm x 1 m
INSTALLED: Pattern by Tile

F



PRODUCT: Online
CONTROL: PG-005E
ITEM: 328178
COLOR/SAMPLE: 190719 _267549-098
SIZE: 25 cm x 1 m
INSTALLED: Pattern by Tile

G



PRODUCT: Online
CONTROL: PG-005G
ITEM: 328180
COLOR: 192251
SAMPLE: 267549-215
SIZE: 25 cm x 1 m
INSTALLED: Pattern by Tile

ECLECTIC SCHEME/GENERIC GUESTROOM PROTOTYPE ORDER INFORMATION

Carpet tiles **SAVE APPROXIMATELY 18%-20% IN PRODUCT WASTE** versus broadloom, based on prototype layout.



PRODUCT	KIT#	CONTROL#	ITEM#	COLOR#	SAMPLE#	SIZE	INSTALLATION
A LVT Natural Woodgrains		X-010	276813	A00207 Washed Wheat		25 cm x 1 m	Ashlar
*B Area Rug Kit	98.1110.24	X-004-GA-ALT1	299177			2 m x 2 m	Pattern by Tile
Custom				186696	265403-012		
Custom				188122	265403-185		
B Area Rug Kit	98.1110.25	X-005-GA-ALT1	299179			3 m x 2 m	Pattern by Tile
Custom				186696	265403-012		
Custom				188122	265403-185		

**Scene represents 2 m x 2 m rug kit.*

INSTALLATION SPECIFICATIONS	CONTROL#	ITEM#	DESCRIPTION
XL Brands 2000 Plus Adhesive			Double stick install
Selitbloc Underlayment	X-011	276822	Underlayment for entire room with carpet and LVT system

ECLECTIC SCHEME/GENERIC GUESTROOM INSTALLATION PLAN

All quantities are estimates only and are based on plans provided. Site measurements and field verifications are recommended to ensure accuracy. These quantities are not intended to be used for material ordering purposes. Since waste factors may vary by installer, actual ordering quantities are the responsibility of your flooring contractor.

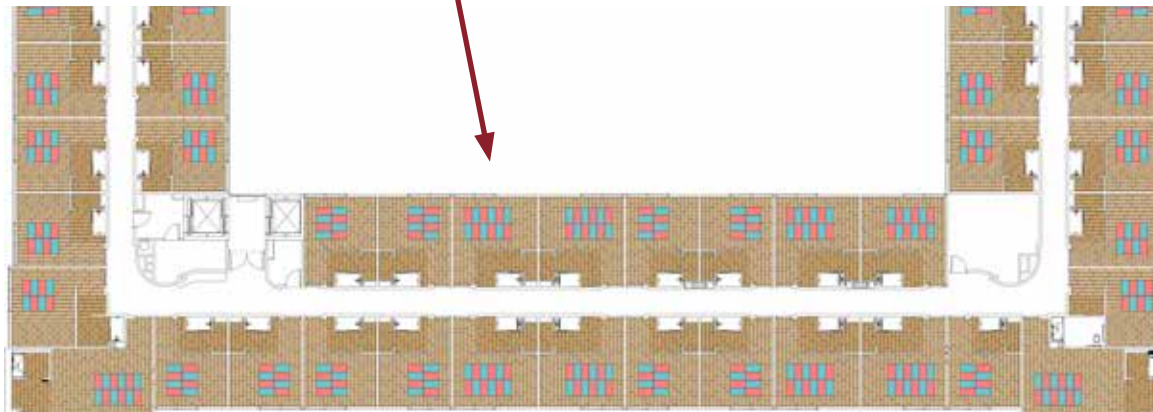

LEGEND

A

DRY

WET



PRODUCT: LVT Natural Woodgrains
CONTROL: X-010
ITEM: 276813
COLOR: A00207 Washed Wheat
SIZE: 25 cm x 1 m
INSTALLED: Ashlar

B



PRODUCT: Custom
CONTROL: X-004-GA-ALT1
ITEM: 299177
COLOR/SAMPLE: 186696_265403-012
SIZE: 50 cm x 1 m
INSTALLED: Pattern by Tile

B



PRODUCT: Custom
CONTROL: X-004-GA-ALT1
ITEM: 299177
COLOR/SAMPLE: 188122_265403-185
SIZE: 50 cm x 1 m
INSTALLED: Pattern by Tile

ECLECTIC SCHEME/BIG GREEN GUESTROOM PROTOTYPE ORDER INFORMATION

Carpet tiles **SAVE APPROXIMATELY 18%-20% IN PRODUCT WASTE** versus broadloom, based on prototype layout.



PRODUCT	KIT#	CONTROL#	ITEM#	COLOR#	SAMPLE#	SIZE	INSTALLATION
A LVT Natural Woodgrains		X-010	276813	A00207 Washed Wheat		25 cm x 1 m	Ashlar
*B Area Rug Kit	98.1110.22	X-004-BG-ALT2	299142			2 m x 2 m	Pattern by Tile
Custom				188124	265403-188		
Custom				188123	265403-187		
B Area Rug Kit	98.1110.23	X-005-GA-ALT2	299140			3 m x 2 m	Pattern by Tile
Custom				188124	265403-188		
Custom				188123	265403-187		

**Scene represents 2 m x 2 m rug kit.*

INSTALLATION SPECIFICATIONS	CONTROL#	ITEM#	DESCRIPTION
XL Brands 2000 Plus Adhesive			Double stick install
Selitbloc Underlayment	X-011	276822	Underlayment for entire room with carpet and LVT system

ECLECTIC SCHEME/BIG GREEN GUESTROOM INSTALLATION PLAN

All quantities are estimates only and are based on plans provided. Site measurements and field verifications are recommended to ensure accuracy. These quantities are not intended to be used for material ordering purposes. Since waste factors may vary by installer, actual ordering quantities are the responsibility of your flooring contractor.

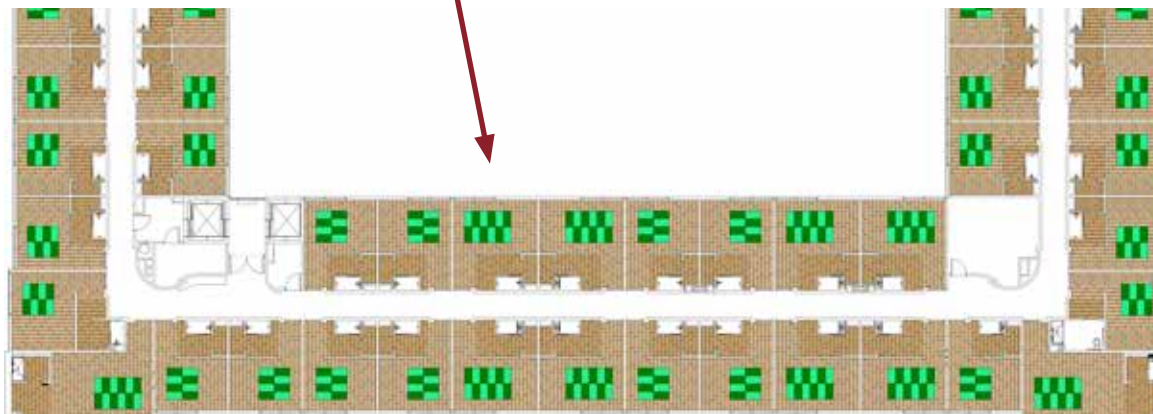

LEGEND

A

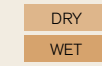

PRODUCT: LVT Natural Woodgrains
CONTROL: X-010
ITEM: 276813
COLOR: A00207 Washed Wheat
SIZE: 25 cm x 1 m
INSTALLED: Ashlar

B



PRODUCT: Custom
CONTROL: X-004-BG-ALT2
ITEM: 299142
COLOR/SAMPLE: 188124_265403-188
SIZE: 50 cm x 1 m
INSTALLED: Pattern by Tile

C



PRODUCT: Custom
CONTROL: X-004_BG-ALT2
ITEM: 299142
COLOR/SAMPLE: 188122_265403-187
SIZE: 50 cm x 1 m
INSTALLED: Pattern by Tile

ECLECTIC SCHEME/ELECTRIC GRID GUESTROOM PROTOTYPE ORDER INFORMATION

Carpet tiles **SAVE APPROXIMATELY 18%-20% IN PRODUCT WASTE** versus broadloom, based on prototype layout.



PRODUCT	KIT#	CONTROL#	ITEM#	COLOR#	SAMPLE#	SIZE	INSTALLATION
A LVT Natural Woodgrains		X-010	276813	A00207 Washed Wheat		25 cm x 1 m	Ashlar
*B Area Rug Kit	98.1110.32	X-004-EG-ALT3	300335			2 m x 2 m	Pattern by Tile
Custom				188239	265403-191		
Custom				188240	265403-191		
B Area Rug Kit	98.1110.33	X-005-EG-ALT3	300331			3 m x 2 m	Pattern by Tile
Custom				188239	265403-191		
Custom				188240	265403-191		

**Scene represents 2 m x 2 m rug kit.*

INSTALLATION SPECIFICATIONS	CONTROL#	ITEM#	DESCRIPTION
XL Brands 2000 Plus Adhesive			Double stick install
Selitbloc Underlayment	X-011	276822	Underlayment for entire room with carpet and LVT system

ECLECTIC SCHEME/ELECTRIC GRID GUESTROOM INSTALLATION PLAN

All quantities are estimates only and are based on plans provided. Site measurements and field verifications are recommended to ensure accuracy. These quantities are not intended to be used for material ordering purposes. Since waste factors may vary by installer, actual ordering quantities are the responsibility of your flooring contractor.

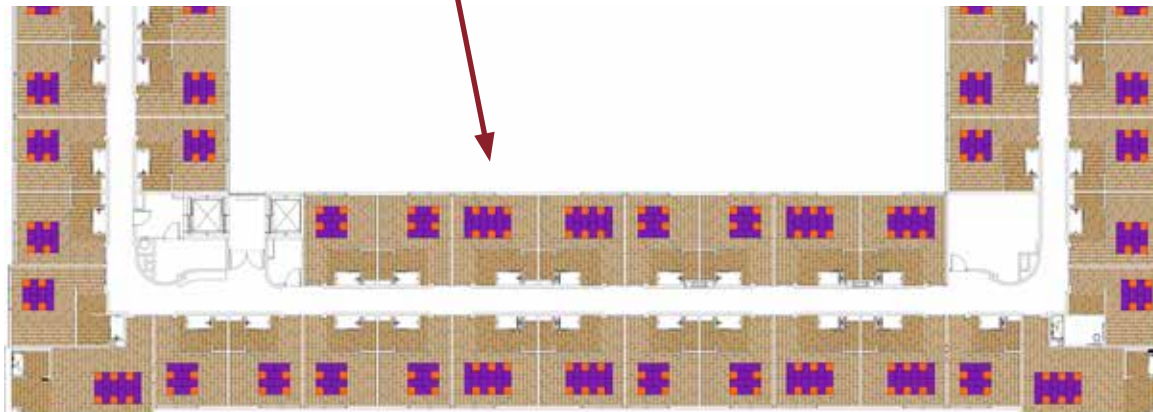

LEGEND

A

DRY

WET



PRODUCT: LVT Natural Woodgrains
CONTROL: X-010
ITEM: 276813
COLOR: A00207 Washed Wheat
SIZE: 25 cm x 1 m
INSTALLED: Ashlar

B

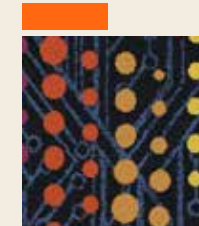

PRODUCT: Custom
CONTROL: X-004-EG-ALT3
ITEM: 300335
COLOR/SAMPLE: 188239_265403-191
SIZE: 50 cm x 50 cm
INSTALLED: Pattern by Tile

B



PRODUCT: Custom
CONTROL: X-004-EG-ALT3
ITEM: 300335
COLOR/SAMPLE: 188240_265403-191
SIZE: 50 cm x 1 m
INSTALLED: Pattern by Tile

ECLECTIC SCHEME/SUMMER SPLASH GUESTROOM PROTOTYPE ORDER INFORMATION

Carpet tiles **SAVE APPROXIMATELY 18%-20% IN PRODUCT WASTE** versus broadloom, based on prototype layout.



PRODUCT	KIT#	CONTROL#	ITEM#	COLOR#	SAMPLE#	SIZE	INSTALLATION
A LVT Natural Woodgrains		X-010	276813	A00207 Washed Wheat		25 cm x 1 m	Ashlar
*B Area Rug Kit	98.1110.37	X-004-SS-ALT4	304065			2 m x 2 m	Pattern by Tile
Custom				188502	267870-090		
Custom				188503	267870-091		
B Area Rug Kit	98.1110.36	X-005-GA-ALT1	304063			3 m x 2 m	Pattern by Tile
Custom				188502	267870-090		
Custom				188503	267870-091		

**Scene represents 2 m x 2 m rug kit.*

INSTALLATION SPECIFICATIONS	CONTROL#	ITEM#	DESCRIPTION
XL Brands 2000 Plus Adhesive			Double stick install
Selitbloc Underlayment	X-011	276822	Underlayment for entire room with carpet and LVT system

ECLECTIC SCHEME/SUMMER SPLASH GUESTROOM INSTALLATION PLAN

All quantities are estimates only and are based on plans provided. Site measurements and field verifications are recommended to ensure accuracy. These quantities are not intended to be used for material ordering purposes. Since waste factors may vary by installer, actual ordering quantities are the responsibility of your flooring contractor.

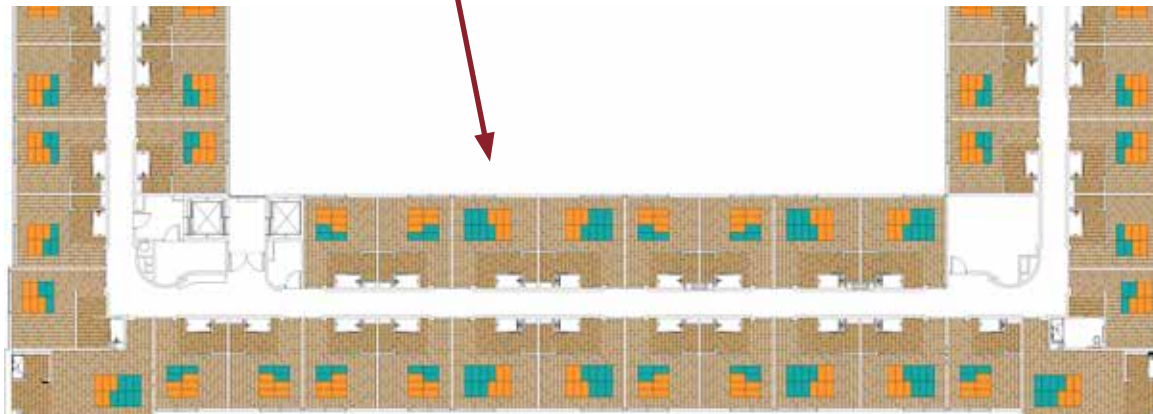

LEGEND

A



PRODUCT: LVT Natural Woodgrains
CONTROL: X-010
ITEM: 276813
COLOR: A00207 Washed Wheat
SIZE: 25 cm x 1 m
INSTALLED: Ashlar

B



PRODUCT: Custom
CONTROL: X-004-SS-ALT4
ITEM: 304065
COLOR/SAMPLE: 188502_267870-090
SIZE: 50 cm x 1 m
INSTALLED: Pattern by Tile

B



PRODUCT: Custom
CONTROL: X-004-SS-ALT4
ITEM: 304065
COLOR/SAMPLE: 188503_267870-091
SIZE: 50 cm x 1 m
INSTALLED: Pattern by Tile

SNOWSCAPE SCHEME GUESTROOM PROTOTYPE ORDER INFORMATION

Carpet tiles **SAVE APPROXIMATELY 18%-20% IN PRODUCT WASTE** versus broadloom, based on prototype layout.



PRODUCT	KIT#	CONTROL#	ITEM#	COLOR#	SAMPLE#	SIZE	INSTALLATION
A LVT Natural Woodgrains		X-010	276813	A00207 Washed Wheat		25 cm x 1 m	Ashlar
*B Area Rug Kit	98.1110.72	X-004-SN-ALT5	328417			2 m x 2 m	Quarter Turn
On The Road Again				190717	267549-084		
B Area Rug Kit	98.1110.71	X-005-SN-ALT5	328418			3 m x 2 m	Quarter Turn
On The Road Again				190717	267549-084		

*Scene represents 2 m x 2 m rug kit.

INSTALLATION SPECIFICATIONS	CONTROL#	ITEM#	DESCRIPTION
XL Brands 2000 Plus Adhesive			Double stick install
Selitbloc Underlayment	X-011	276822	Underlayment for entire room with carpet and LVT system

SNOWSCAPE SCHEME GUESTROOM INSTALLATION PLAN

All quantities are estimates only and are based on plans provided. Site measurements and field verifications are recommended to ensure accuracy. These quantities are not intended to be used for material ordering purposes. Since waste factors may vary by installer, actual ordering quantities are the responsibility of your flooring contractor.

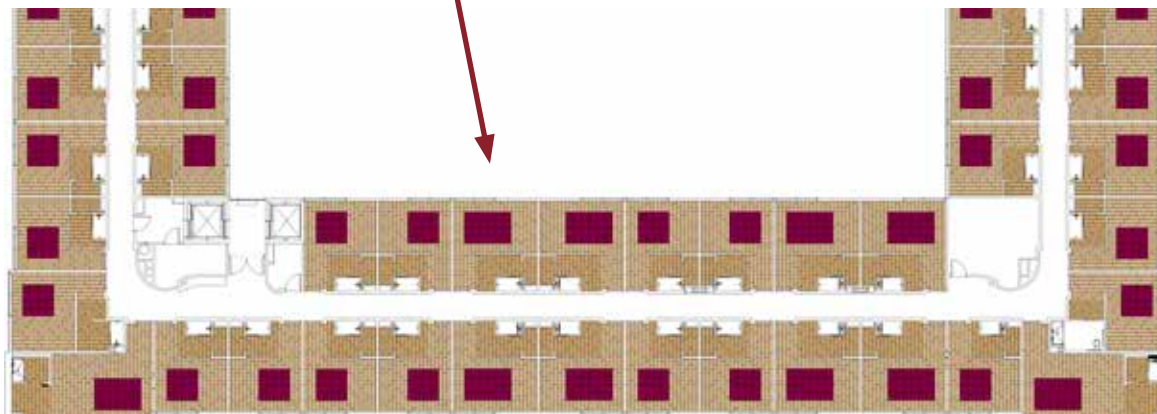

LEGEND

A

DRY

WET



PRODUCT: LVT Natural Woodgrains
CONTROL: X-010
ITEM: 276813
COLOR: A00207 Washed Wheat
SIZE: 25 cm x 1 m
INSTALLED: Ashlar

B

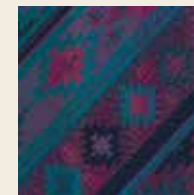

PRODUCT: On the Road Again
CONTROL: X-004-SN-ATL5
ITEM: 328417
COLOR/SAMPLE:
190717_267549-084
SIZE: 50 cm x 50 cm
INSTALLED: Quarter Turn

BACK OF HOUSE PROTOTYPE ORDER INFORMATION

Carpet tiles **SAVE APPROXIMATELY 18%-20% IN PRODUCT WASTE** versus broadloom, based on prototype layout.



PRODUCT	CONTROL#	ITEM#	COLOR#	SAMPLE#	SIZE	INSTALLATION
Cloud Cover	OA-001	320569	189839	267549-069	50 cm x 50 cm	Non Directional

INSTALLATION SPECIFICATIONS	CONTROL#	ITEM#	DESCRIPTION
XL Brands 2000 Plus Adhesive			Double stick install

BACK OF HOUSE INSTALLATION PLAN

All quantities are estimates only and are based on plans provided. Site measurements and field verifications are recommended to ensure accuracy. These quantities are not intended to be used for material ordering purposes. Since waste factors may vary by installer, actual ordering quantities are the responsibility of your flooring contractor.



LEGEND



PRODUCT: Cloud Cover
CONTROL: OA-001
ITEM: 320569
COLOR/SAMPLE:
189839_267549-069
SIZE: 50 cm x 50 cm
INSTALLED: Non Directional

Interface®

COURTYARD



APPROVED PROTOTYPES

Aloft Hotels
Courtyard
Delta Hotels
Element
Fairfield Inn & Suites
Four Points
Marriott Hotels
Residence Inn
Sheraton
TownePlace Suites

INSPIRED CLASSIC CORRIDOR PROTOTYPE ORDER INFORMATION

Carpet tiles **SAVE APPROXIMATELY 18%-20% IN PRODUCT WASTE** versus broadloom, based on prototype layout.



PRODUCT	CONTROL#	ITEM#	COLOR#	SAMPLE#	SIZE	INSTALLATION
A Custom	PG-001ALT4	315711	189264	26859-138	25 cm x 1 m	Ashlar
B Custom	PG-005ALT4	315713	189263	268596-138	50 cm x 50 cm	Brick
Custom 4" Carpet Base			189757	268596-196	4" x 25' Rolls	

INSTALLATION SPECIFICATIONS	DESCRIPTION
XL2000 PLUS Adhesive	Double stick install

INSPIRED CLASSIC CORRIDOR INSTALLATION PLAN

All quantities are estimates only and are based on plans provided. Site measurements and field verifications are recommended to ensure accuracy. These quantities are not intended to be used for material ordering purposes. Since waste factors may vary by installer, actual ordering quantities are the responsibility of your flooring contractor.

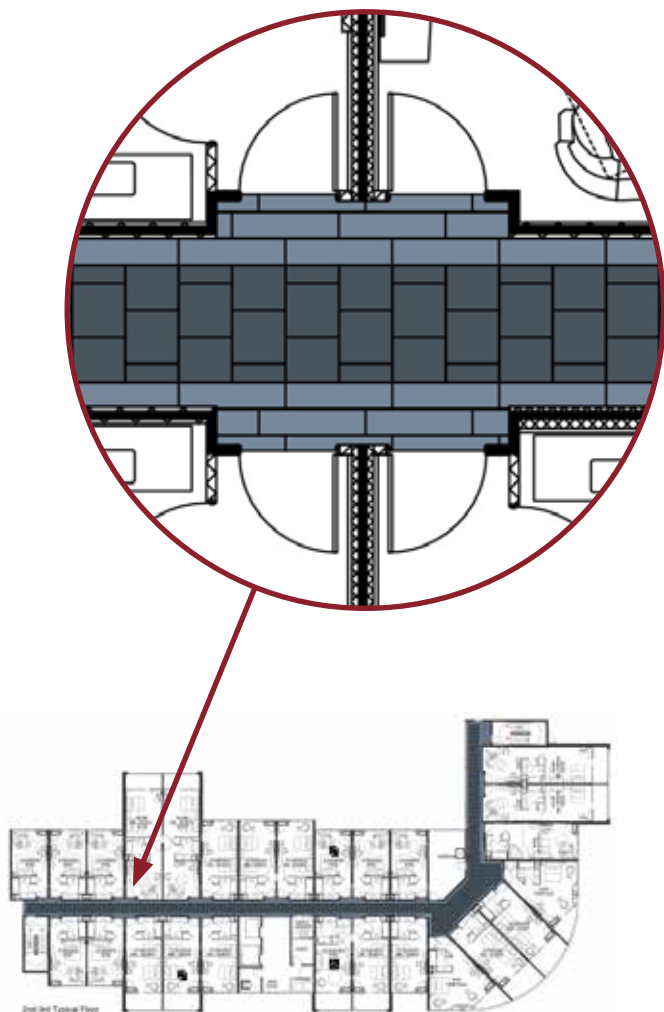

LEGEND

A



PRODUCT: Custom
CONTROL: PG-001ALT4
ITEM: 315711
COLOR/SAMPLE:
189264_268596-138
SIZE: 25 cm x 1 m
INSTALLED: Ashlar

B



PRODUCT: Custom
CONTROL: PG-005ALT4
ITEM: 315713
COLOR/SAMPLE:
189263_268596-151
SIZE: 50 cm x 50 cm
INSTALLED: Brick

INSPIRED CLASSIC ELEVATOR LOBBY PROTOTYPE ORDER INFORMATION

Carpet tiles **SAVE APPROXIMATELY 18%-20% IN PRODUCT WASTE** versus broadloom, based on prototype layout.



PRODUCT	CONTROL#	ITEM#	COLOR#	SAMPLE#	SIZE	INSTALLATION
A Custom	PG-001ALT4	315711	189264	268596-138	25 cm x 1 m	Ashlar
B Custom	PG-002ALT4	315714	189265	268596-152	50 cm x 50 cm	Brick
Custom 4" Carpet Base			189757	268596-196	4" x 25' Rolls	

INSTALLATION SPECIFICATIONS	DESCRIPTION
XL2000 PLUS Adhesive	Double stick install

INSPIRED CLASSIC ELEVATOR LOBBY INSTALLATION PLAN

All quantities are estimates only and are based on plans provided. Site measurements and field verifications are recommended to ensure accuracy. These quantities are not intended to be used for material ordering purposes. Since waste factors may vary by installer, actual ordering quantities are the responsibility of your flooring contractor.

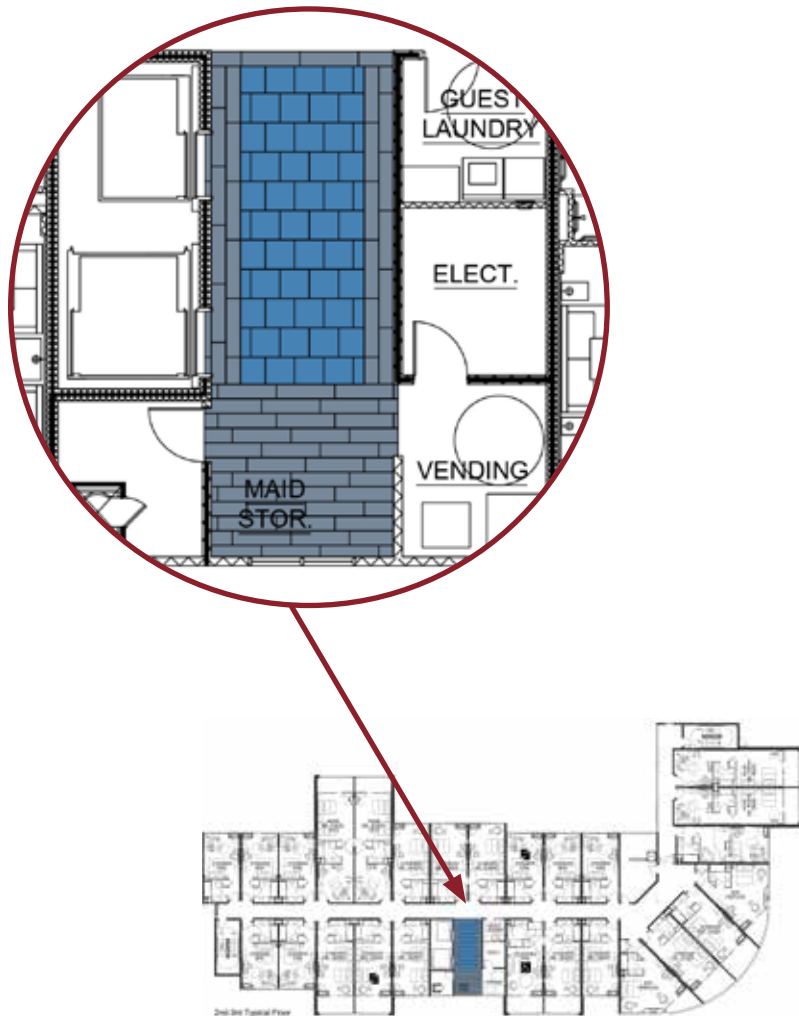

LEGEND

A



PRODUCT: Custom
CONTROL: PG-001ALT4
ITEM: 315711
COLOR/SAMPLE:
189264_268596-138
SIZE: 25 cm x 1 m
INSTALLED: Ashlar

B

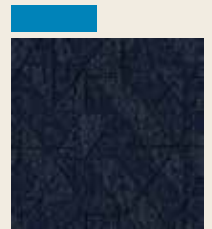

PRODUCT: Custom
CONTROL: PG-002ALT4
ITEM: 315714
COLOR/SAMPLE:
189265_268596-152
SIZE: 50 cm x 50 cm
INSTALLED: Brick

INSPIRED CLASSIC LOUNGE PROTOTYPE ORDER INFORMATION

Carpet tiles **SAVE APPROXIMATELY 18%-20% IN PRODUCT WASTE** versus broadloom, based on prototype layout.



PRODUCT	CONTROL#	ITEM#	COLOR#	SAMPLE#	SIZE	INSTALLATION
Custom	LM-001ALT4	315715	189266	268596-153	50 cm x 50 cm	Brick
Custom 4" Carpet Base			189757	268596-196	4" x 25' Rolls	

INSTALLATION SPECIFICATIONS	DESCRIPTION
XL2000 PLUS Adhesive	Double stick install

INSPIRED CLASSIC LOUNGE INSTALLATION PLAN

All quantities are estimates only and are based on plans provided. Site measurements and field verifications are recommended to ensure accuracy. These quantities are not intended to be used for material ordering purposes. Since waste factors may vary by installer, actual ordering quantities are the responsibility of your flooring contractor.

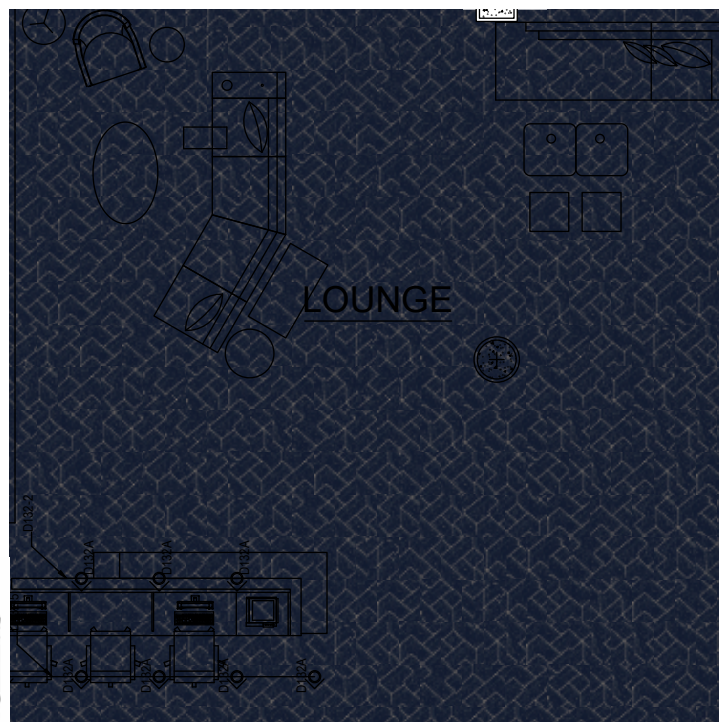
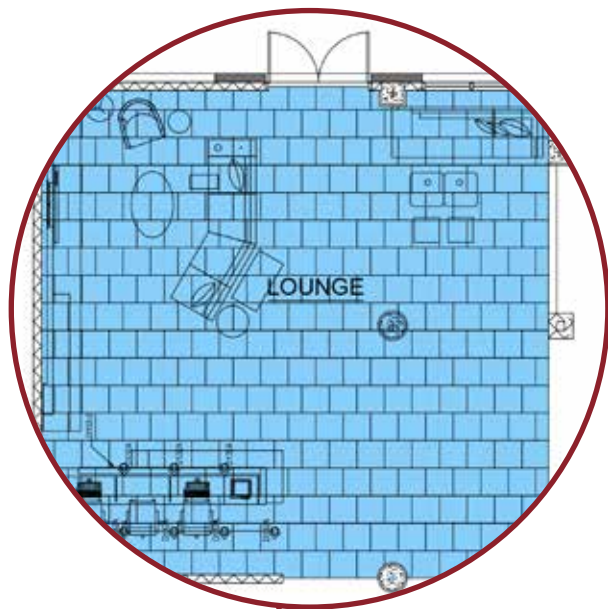

LEGEND

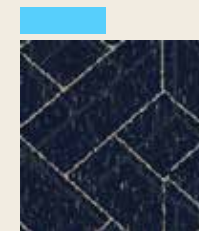

PRODUCT: Custom
CONTROL: LM-001ALT4
ITEM: 315715
COLOR/SAMPLE:
189266_268596-153
SIZE: 50 cm x 50 cm
INSTALLED: Brick

INSPIRED CLASSIC MEETING ROOM PROTOTYPE ORDER INFORMATION

Carpet tiles **SAVE APPROXIMATELY 18%-20% IN PRODUCT WASTE** versus broadloom, based on prototype layout.



PRODUCT	CONTROL#	ITEM#	COLOR#	SAMPLE#	SIZE	INSTALLATION
Custom	MR-001ALT4	315716	189267	268596-158	50 cm x 50 cm	Brick
Custom 4" Carpet Base			189757	268596-196	4" x 25' Rolls	

INSTALLATION SPECIFICATIONS	DESCRIPTION
XL2000 PLUS Adhesive	Double stick install

INSPIRED CLASSIC MEETING ROOM INSTALLATION PLAN

All quantities are estimates only and are based on plans provided. Site measurements and field verifications are recommended to ensure accuracy. These quantities are not intended to be used for material ordering purposes. Since waste factors may vary by installer, actual ordering quantities are the responsibility of your flooring contractor.

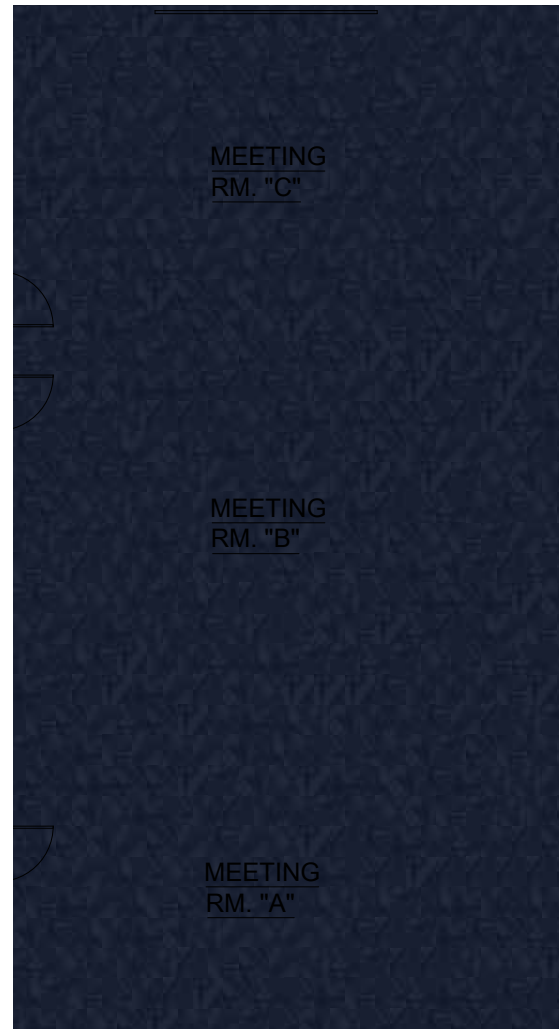
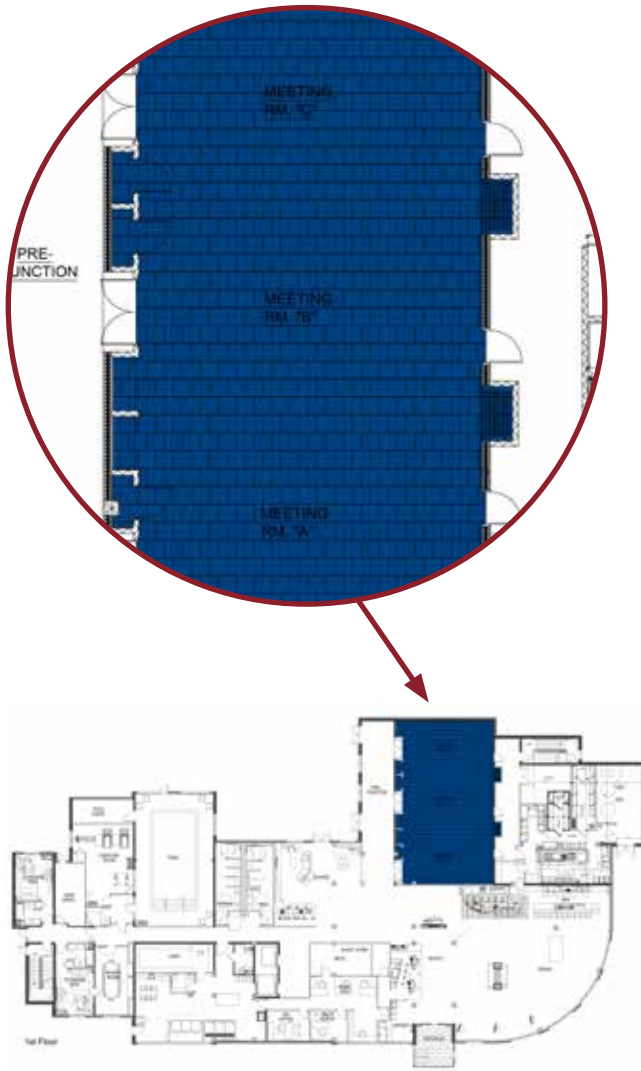

LEGEND



PRODUCT: Custom
CONTROL: MR-001ALT4
ITEM: 315716
COLOR/SAMPLE:
189267_268596-158
SIZE: 50 cm x 50 cm
INSTALLED: Brick

Interface®

DELTA



APPROVED PROTOTYPES

Aloft Hotels
Courtyard
Delta Hotels
Element
Fairfield Inn & Suites
Four Points
Marriott Hotels
Residence Inn
Sheraton
TownePlace Suites

SIMPLY CRAFTED MINT DÉCOR KING GUESTROOM PROTOTYPE ORDER INFORMATION

Carpet tiles **SAVE APPROXIMATELY 18%-20% IN PRODUCT WASTE** versus broadloom, based on prototype layout.



PRODUCT	KIT#	CONTROL#	ITEM#	COLOR#	SAMPLE#	SIZE	INSTALLATION
*A LVT Textured Woodgrains		X-004-LT-OPT	313007	A00406 Antique Light Oak		25 cm x 1 m	Ashlar
A LVT Textured Woodgrains		X-004-DK-OPT	313008	A00409 Ash Walnut		25 cm x 1 m	Ashlar
B Area Rug Kit	98.1110.64	K-003-M-OPT	326780			8'-2" x 9'-10"	Ashlar
Custom				190317	267948-117		

**Select from either LVT listed above. Scene represents Antique Light Oak.*

INSTALLATION SPECIFICATIONS	CONTROL#	ITEM#	DESCRIPTION
XL Brands 2000 Plus Adhesive			Double stick install
Selitbloc Underlayment	X-005-OPT	276822	Underlayment for entire room with carpet and LVT system

***Pad not required with carpet tile but acoustical underlayment is required with the LVT and carpet tile system.*

SIMPLY CRAFTED MINT DÉCOR KING GUESTROOM INSTALLATION PLAN

All quantities are estimates only and are based on plans provided. Site measurements and field verifications are recommended to ensure accuracy. These quantities are not intended to be used for material ordering purposes. Since waste factors may vary by installer, actual ordering quantities are the responsibility of your flooring contractor.

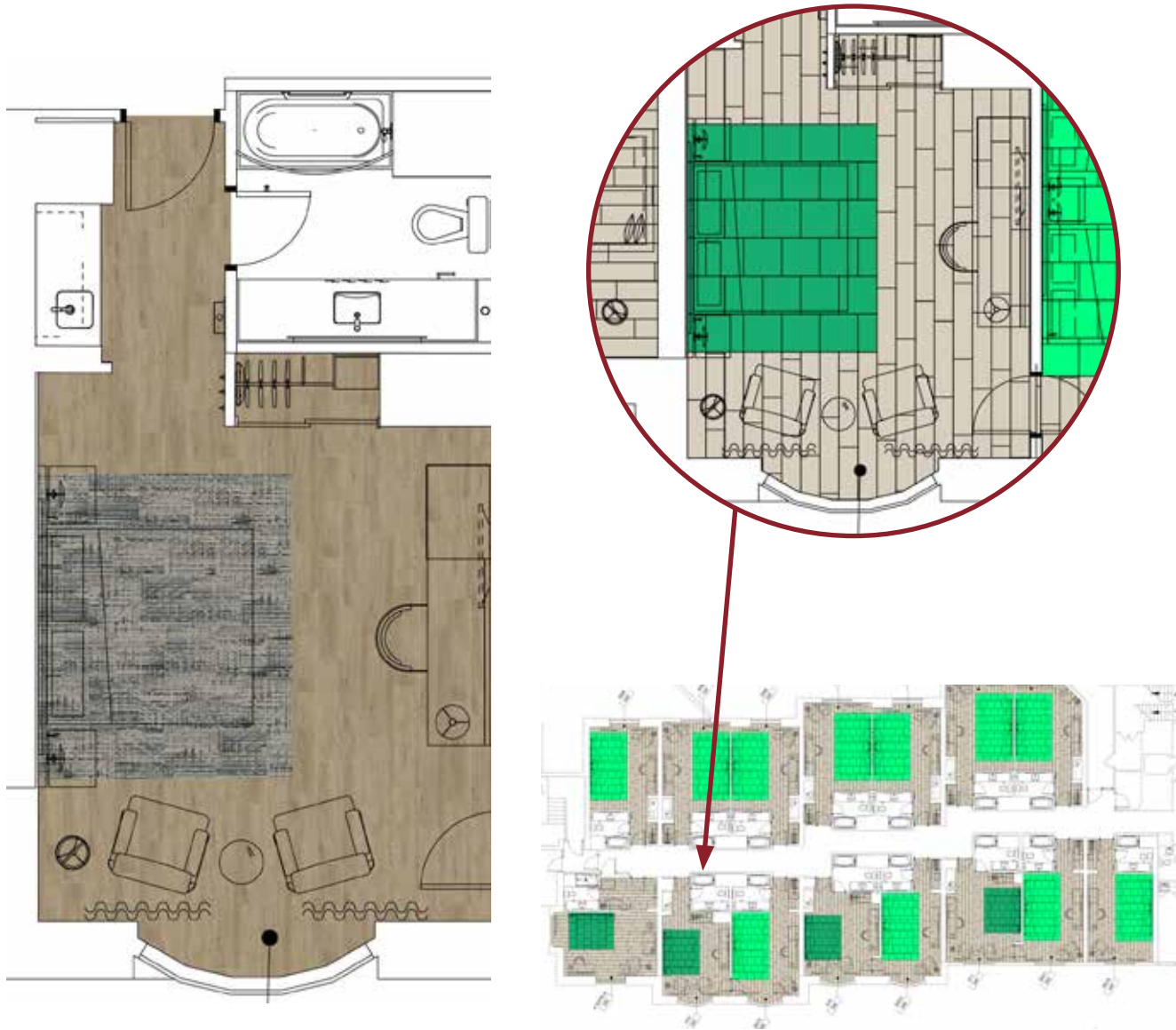

LEGEND

A



B

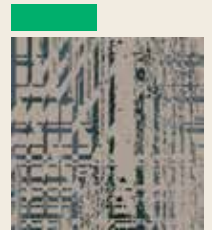

PRODUCT:
LVT Textured Woodgrains
CONTROL: X-004-LT-OPT
ITEM: 313007
COLOR: A00406 Antique
Light Oak
SIZE: 25 cm x 1 m
INSTALLED: Ashlar

PRODUCT: Custom
CONTROL: K-003-M-OPT
ITEM: 326780
COLOR/SAMPLE:
190317_267548-117
SIZE: 50 cm x 50 cm
INSTALLED: Ashlar

SIMPLY CRAFTED MINT DÉCOR KING GUESTROOM PROTOTYPE ORDER INFORMATION

Carpet tiles **SAVE APPROXIMATELY 18%-20% IN PRODUCT WASTE** verses broadloom, based on prototype layout.



PRODUCT	KIT#	CONTROL#	ITEM#	COLOR#	SAMPLE#	SIZE	INSTALLATION
A LVT Textured Woodgrains		X-004-LT-OPT	313007	A00406 Antique Light Oak		25 cm x 1 m	Ashlar
*A LVT Textured Woodgrains		X-004-DK-OPT	313008	A00409 Ash Walnut		25 cm x 1 m	Ashlar
B Area Rug Kit	98.1110.64	K-003-M-OPT	326780			8'-2" x 9'-10"	Ashlar
Custom				190317	267948-117		

**Select from either LVT listed above. Scene represents Ash Walnut.*

INSTALLATION SPECIFICATIONS	CONTROL#	ITEM#	DESCRIPTION
XL Brands 2000 Plus Adhesive			Double stick install
Selitbloc Underlayment	X-005-OPT	276822	Underlayment for entire room with carpet and LVT system

***Pad not required with carpet tile but acoustical underlayment is required with the LVT and carpet tile system.*

SIMPLY CRAFTED MINT DÉCOR KING GUESTROOM INSTALLATION PLAN

All quantities are estimates only and are based on plans provided. Site measurements and field verifications are recommended to ensure accuracy. These quantities are not intended to be used for material ordering purposes. Since waste factors may vary by installer, actual ordering quantities are the responsibility of your flooring contractor.

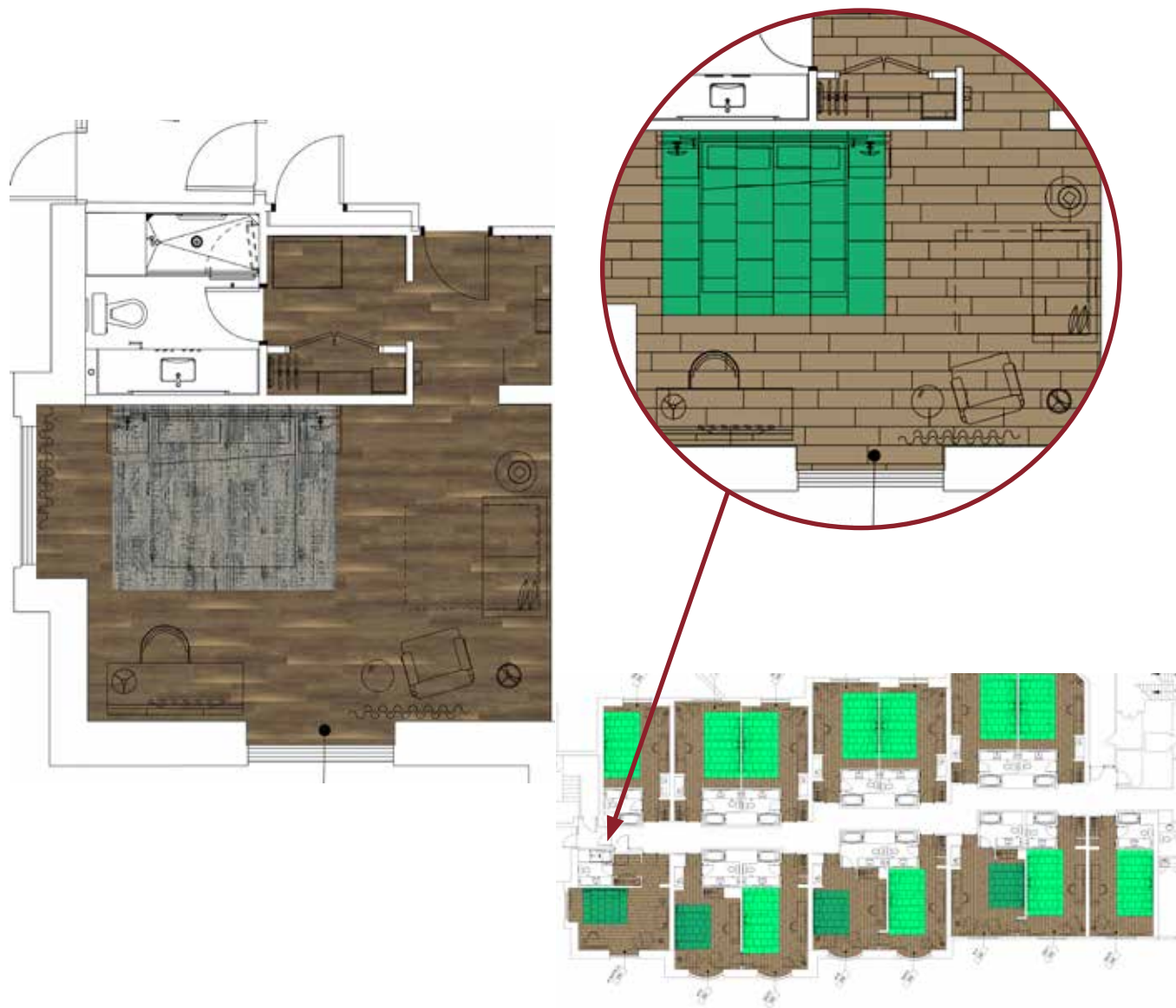

LEGEND

A



PRODUCT:
LVT Textured Woodgrains
CONTROL: X-004-DK-OPT
ITEM: 313008
COLOR: A00409
Ash Walnut
SIZE: 25 cm x 1 m
INSTALLED: Ashlar

B

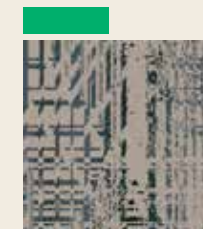

PRODUCT: Custom
CONTROL: K-003-M-OPT
ITEM: 326780
COLOR/SAMPLE:
190317_267548-117
SIZE: 50 cm x 50 cm
INSTALLED: Ashlar

SIMPLY CRAFTED MINT DÉCOR QUEEN GUESTROOM GUESTROOM PROTOTYPE ORDER INFORMATION

Carpet tiles **SAVE APPROXIMATELY 18%-20% IN PRODUCT WASTE** versus broadloom, based on prototype layout.



PRODUCT	KIT#	CONTROL#	ITEM#	COLOR#	SAMPLE#	SIZE	INSTALLATION
*A LVT Textured Woodgrains		X-004-LT-OPT	313007	A00406 Antique Light Oak		25 cm x 1 m	Ashlar
A LVT Textured Woodgrains		X-004-DK-OPT	313008	A00409 Ash Walnut		25 cm x 1 m	Ashlar
B Area Rug Kit	98.1110.65	Q-003-M-OPT	326781			8'-2" x 14'-9"	Ashlar
Custom				190317	267948-117		

**Select from either LVT listed above. Scene represents Antique Light Oak.*

INSTALLATION SPECIFICATIONS	CONTROL#	ITEM#	DESCRIPTION
XL Brands 2000 Plus Adhesive			Double stick install
Selitbloc Underlayment	X-005-OPT	276822	Underlayment for entire room with carpet and LVT system

***Pad not required with carpet tile but acoustical underlayment is required with the LVT and carpet tile system.*

SIMPLY CRAFTED MINT DÉCOR QUEEN GUESTROOM INSTALLATION PLAN

All quantities are estimates only and are based on plans provided. Site measurements and field verifications are recommended to ensure accuracy. These quantities are not intended to be used for material ordering purposes. Since waste factors may vary by installer, actual ordering quantities are the responsibility of your flooring contractor.



LEGEND

A



B



PRODUCT:
LVT Textured Woodgrains
CONTROL: X-004-LT-OPT
ITEM: 313007
COLOR: A00406 Antique
Light Oak
SIZE: 25 cm x 1 m
INSTALLED: Ashlar

PRODUCT: Custom
CONTROL: Q-003-M-OPT
ITEM: 326781
COLOR/SAMPLE:
190317_267548-117
SIZE: 50 cm x 50 cm
INSTALLED: Ashlar

SIMPLY CRAFTED MINT DÉCOR QUEEN GUESTROOM GUESTROOM PROTOTYPE ORDER INFORMATION

Carpet tiles **SAVE APPROXIMATELY 18%-20% IN PRODUCT WASTE** verses broadloom, based on prototype layout.



PRODUCT	KIT#	CONTROL#	ITEM#	COLOR#	SAMPLE#	SIZE	INSTALLATION
A LVT Textured Woodgrains		X-004-LT-OPT	313007	A00406 Antique Light Oak		25 cm x 1 m	Ashlar
*A LVT Textured Woodgrains		X-004-DK-OPT	313008	A00409 Ash Walnut		25 cm x 1 m	Ashlar
B Area Rug Kit	98.1110.65	Q-003-M-OPT	326781			8'-2" x 14'-9"	Ashlar
Custom				190317	267948-117		

**Select from either LVT listed above. Scene represents Ash Walnut.*

INSTALLATION SPECIFICATIONS	CONTROL#	ITEM#	DESCRIPTION
XL Brands 2000 Plus Adhesive			Double stick install
Selitbloc Underlayment	X-005-OPT	276822	Underlayment for entire room with carpet and LVT system

***Pad not required with carpet tile but acoustical underlayment is required with the LVT and carpet tile system.*

SIMPLY CRAFTED MINT DÉCOR QUEEN GUESTROOM INSTALLATION PLAN

All quantities are estimates only and are based on plans provided. Site measurements and field verifications are recommended to ensure accuracy. These quantities are not intended to be used for material ordering purposes. Since waste factors may vary by installer, actual ordering quantities are the responsibility of your flooring contractor.



LEGEND

A



B



PRODUCT:
LVT Textured Woodgrains
CONTROL: X-004-DK-OPT
ITEM: 313008
COLOR: A00409
Ash Walnut
SIZE: 25 cm x 1 m
INSTALLED: Ashlar

PRODUCT: Custom
CONTROL: Q-003-M-OPT
ITEM: 326781
COLOR/SAMPLE:
190317_267548-117
SIZE: 50 cm x 50 cm
INSTALLED: Ashlar

SIMPLY CRAFTED PLUM DÉCOR KING GUESTROOM PROTOTYPE ORDER INFORMATION

Carpet tiles **SAVE APPROXIMATELY 18%-20% IN PRODUCT WASTE** versus broadloom, based on prototype layout.



PRODUCT	KIT#	CONTROL#	ITEM#	COLOR#	SAMPLE#	SIZE	INSTALLATION
*A LVT Textured Woodgrains		X-004-LT-OPT	313007	A00406 Antique Light Oak		25 cm x 1 m	Ashlar
A LVT Textured Woodgrains		X-004-DK-OPT	313008	A00409 Ash Walnut		25 cm x 1 m	Ashlar
B Area Rug Kit	98.1110.69	K-003-OPT-P	309673			8'-2" x 9'-10"	Ashlar
Custom				190316	267948-116		

**Select from either LVT listed above. Scene represents Antique Light Oak.*

INSTALLATION SPECIFICATIONS	CONTROL#	ITEM#	DESCRIPTION
XL Brands 2000 Plus Adhesive			Double stick install
Selitbloc Underlayment	X-005-OPT	276822	Underlayment for entire room with carpet and LVT system

***Pad not required with carpet tile but acoustical underlayment is required with the LVT and carpet tile system.*

SIMPLY CRAFTED PLUM DÉCOR KING GUESTROOM INSTALLATION PLAN

All quantities are estimates only and are based on plans provided. Site measurements and field verifications are recommended to ensure accuracy. These quantities are not intended to be used for material ordering purposes. Since waste factors may vary by installer, actual ordering quantities are the responsibility of your flooring contractor.

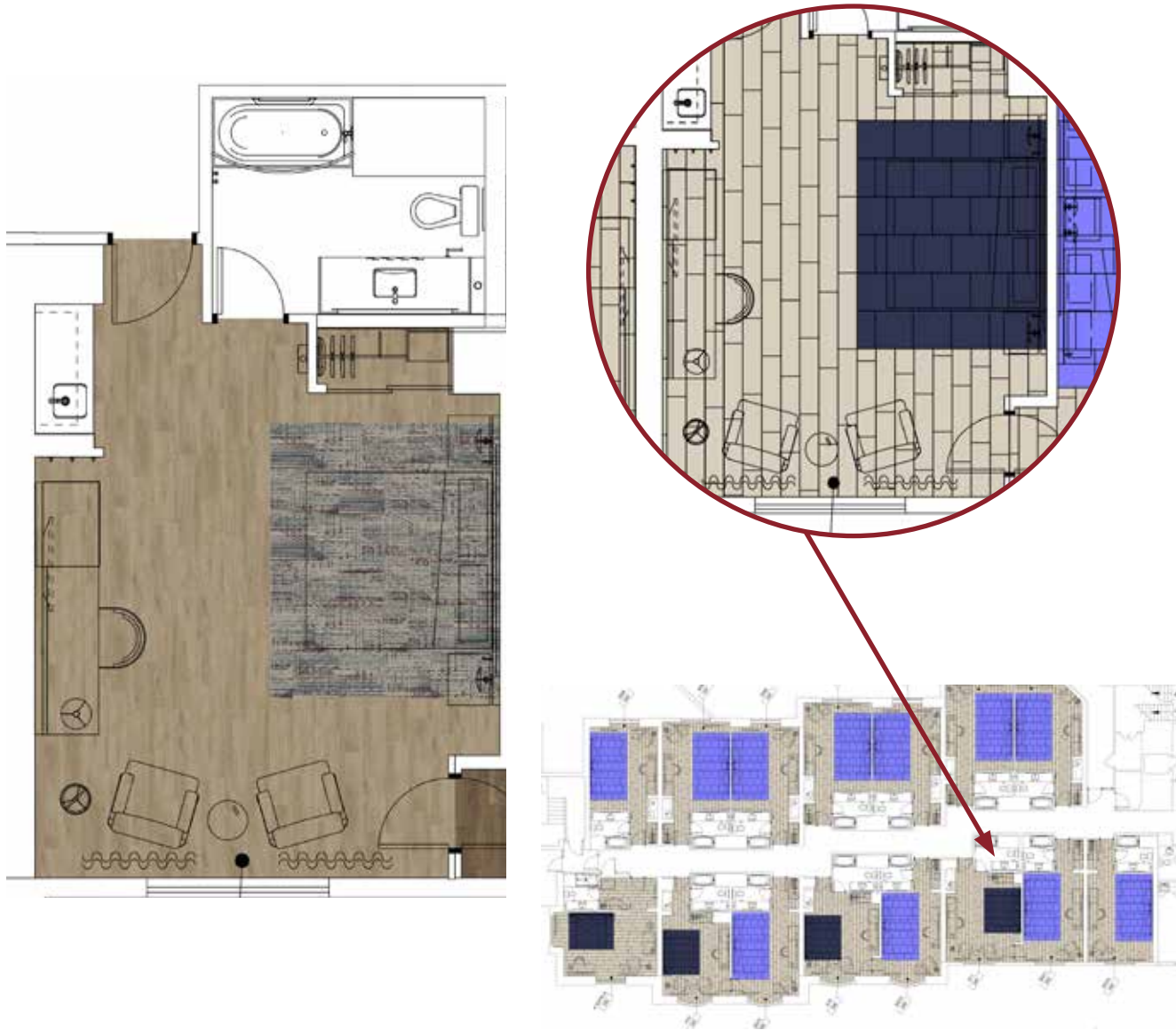

LEGEND

A



B

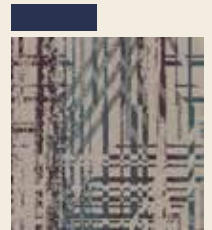

PRODUCT:
LVT Textured Woodgrains
CONTROL: X-004-LT-OPT
ITEM: 313007
COLOR: A00406 Antique
Light Oak
SIZE: 25 cm x 1 m
INSTALLED: Ashlar

PRODUCT: Custom
CONTROL: K-003-OPT-P
ITEM: 309673
COLOR/SAMPLE:
190316_267948-116
SIZE: 50 cm x 50 cm
INSTALLED: Ashlar

SIMPLY CRAFTED PLUM DÉCOR KING GUESTROOM PROTOTYPE ORDER INFORMATION

Carpet tiles **SAVE APPROXIMATELY 18%-20% IN PRODUCT WASTE** versus broadloom, based on prototype layout.



PRODUCT	KIT#	CONTROL#	ITEM#	COLOR#	SAMPLE#	SIZE	INSTALLATION
A LVT Textured Woodgrains		X-004-LT-OPT	313007	A00406 Antique Light Oak		25 cm x 1 m	Ashlar
*A LVT Textured Woodgrains		X-004-DK-OPT	313008	A00409 Ash Walnut		25 cm x 1 m	Ashlar
B Area Rug Kit	98.1110.69	K-003-OPT-P	309673			8'-2" x 9'-10"	Ashlar
Custom				190316	267948-116		

**Select from either LVT listed above. Scene represents Ash Walnut.*

INSTALLATION SPECIFICATIONS	CONTROL#	ITEM#	DESCRIPTION
XL Brands 2000 Plus Adhesive			Double stick install
Selitbloc Underlayment	X-005-OPT	276822	Underlayment for entire room with carpet and LVT system

***Pad not required with carpet tile but acoustical underlayment is required with the LVT and carpet tile system.*

SIMPLY CRAFTED PLUM DÉCOR KING GUESTROOM INSTALLATION PLAN

All quantities are estimates only and are based on plans provided. Site measurements and field verifications are recommended to ensure accuracy. These quantities are not intended to be used for material ordering purposes. Since waste factors may vary by installer, actual ordering quantities are the responsibility of your flooring contractor.

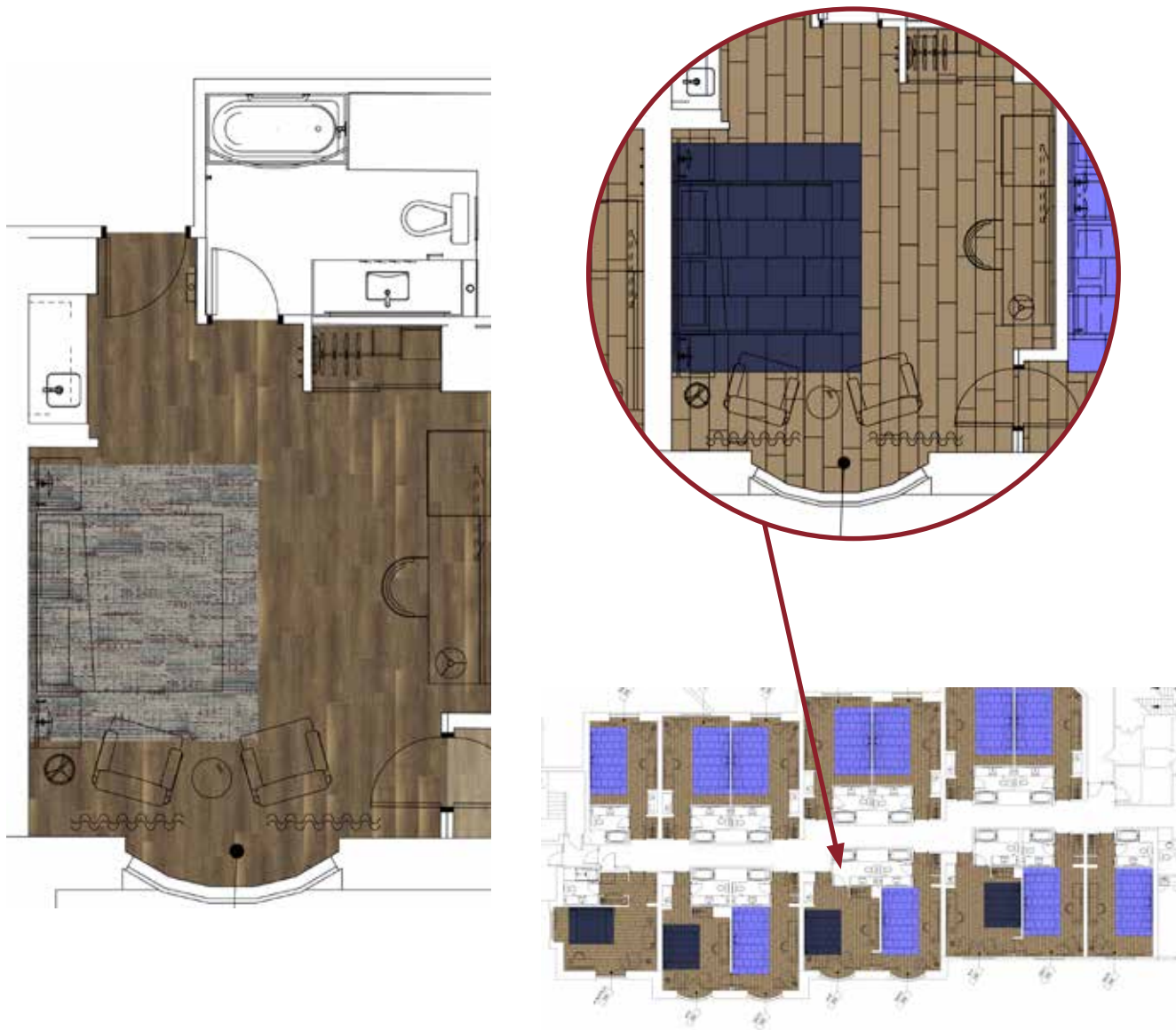

LEGEND

A



B

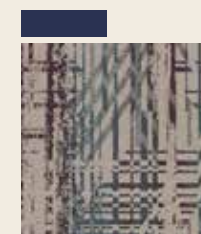

PRODUCT:
LVT Textured Woodgrains
CONTROL: X-004-DK-OPT
ITEM: 313008
COLOR: A00409
Ash Walnut
SIZE: 25 cm x 1 m
INSTALLED: Ashlar

PRODUCT: Custom
CONTROL: K-003-OPT-P
ITEM: 309673
COLOR/SAMPLE:
190316_267948-116
SIZE: 50 cm x 50 cm
INSTALLED: Ashlar

SIMPLY CRAFTED PLUM DÉCOR QUEEN GUESTROOM GUESTROOM PROTOTYPE ORDER INFORMATION

Carpet tiles **SAVE APPROXIMATELY 18%-20% IN PRODUCT WASTE** verses broadloom, based on prototype layout.



PRODUCT	KIT#	CONTROL#	ITEM#	COLOR#	SAMPLE#	SIZE	INSTALLATION
*A LVT Textured Woodgrains		X-004-LT-OPT	313007	A00406 Antique Light Oak		25 cm x 1 m	Ashlar
A LVT Textured Woodgrains		X-004-DK-OPT	313008	A00409 Ash Walnut		25 cm x 1 m	Ashlar
B Area Rug Kit	98.1110.69	Q-003-OPT-P	326782			8'-2" x 14'-9"	Ashlar
Custom				190316	267948-116		

**Select from either LVT listed above. Scene represents Antique Light Oak.*

INSTALLATION SPECIFICATIONS	CONTROL#	ITEM#	DESCRIPTION
XL Brands 2000 Plus Adhesive			Double stick install
Selitbloc Underlayment	X-005-OPT	276822	Underlayment for entire room with carpet and LVT system

***Pad not required with carpet tile but acoustical underlayment is required with the LVT and carpet tile system.*

SIMPLY CRAFTED PLUM DÉCOR QUEEN GUESTROOM INSTALLATION PLAN

All quantities are estimates only and are based on plans provided. Site measurements and field verifications are recommended to ensure accuracy. These quantities are not intended to be used for material ordering purposes. Since waste factors may vary by installer, actual ordering quantities are the responsibility of your flooring contractor.

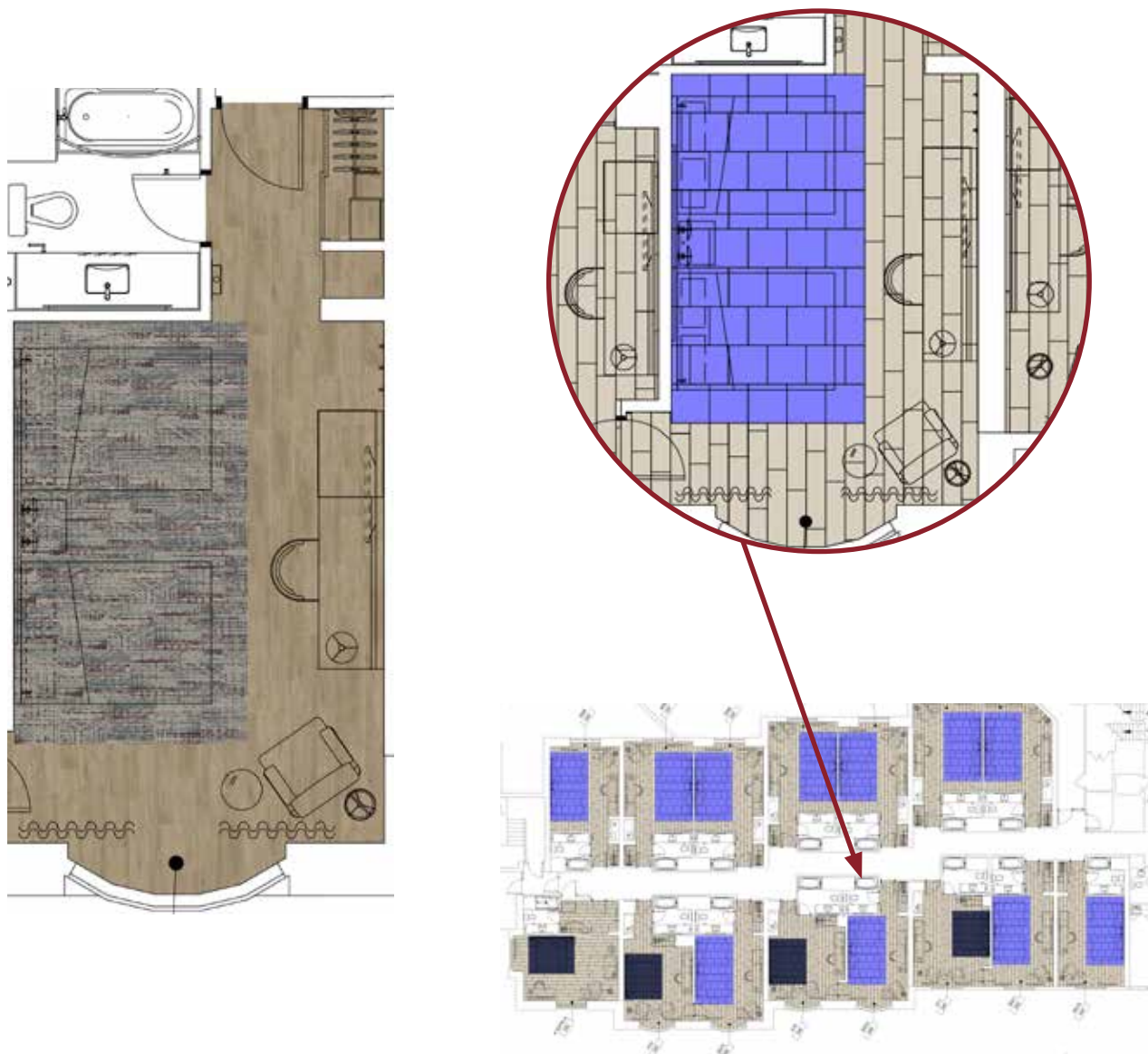

LEGEND

A



B



PRODUCT:
LVT Textured Woodgrains
CONTROL: X-004-LT-OPT
ITEM: 313007
COLOR: A00406 Antique
Light Oak
SIZE: 25 cm x 1 m
INSTALLED: Ashlar

PRODUCT: Custom
CONTROL: Q-003-OPT-P
ITEM: 326782
COLOR/SAMPLE:
190316_267948-116
SIZE: 50 cm x 50 cm
INSTALLED: Ashlar

SIMPLY CRAFTED PLUM DÉCOR QUEEN GUESTROOM GUESTROOM PROTOTYPE ORDER INFORMATION

Carpet tiles **SAVE APPROXIMATELY 18%-20% IN PRODUCT WASTE** versus broadloom, based on prototype layout.



PRODUCT	KIT#	CONTROL#	ITEM#	COLOR#	SAMPLE#	SIZE	INSTALLATION
A LVT Textured Woodgrains		X-004-LT-OPT	313007	A00406 Antique Light Oak		25 cm x 1 m	Ashlar
*A LVT Textured Woodgrains		X-004-DK-OPT	313008	A00409 Ash Walnut		25 cm x 1 m	Ashlar
B Area Rug Kit	98.1110.70	Q-003-OPT-P	326782			8'-2" x 14'-9"	Ashlar
Custom				190316	267948-116		

**Select from either LVT listed above. Scene represents Ash Walnut.*

INSTALLATION SPECIFICATIONS	CONTROL#	ITEM#	DESCRIPTION
XL Brands 2000 Plus Adhesive			Double stick install
Selitbloc Underlayment	X-005-OPT	276822	Underlayment for entire room with carpet and LVT system

***Pad not required with carpet tile but acoustical underlayment is required with the LVT and carpet tile system.*

SIMPLY CRAFTED PLUM DÉCOR QUEEN GUESTROOM INSTALLATION PLAN

All quantities are estimates only and are based on plans provided. Site measurements and field verifications are recommended to ensure accuracy. These quantities are not intended to be used for material ordering purposes. Since waste factors may vary by installer, actual ordering quantities are the responsibility of your flooring contractor.

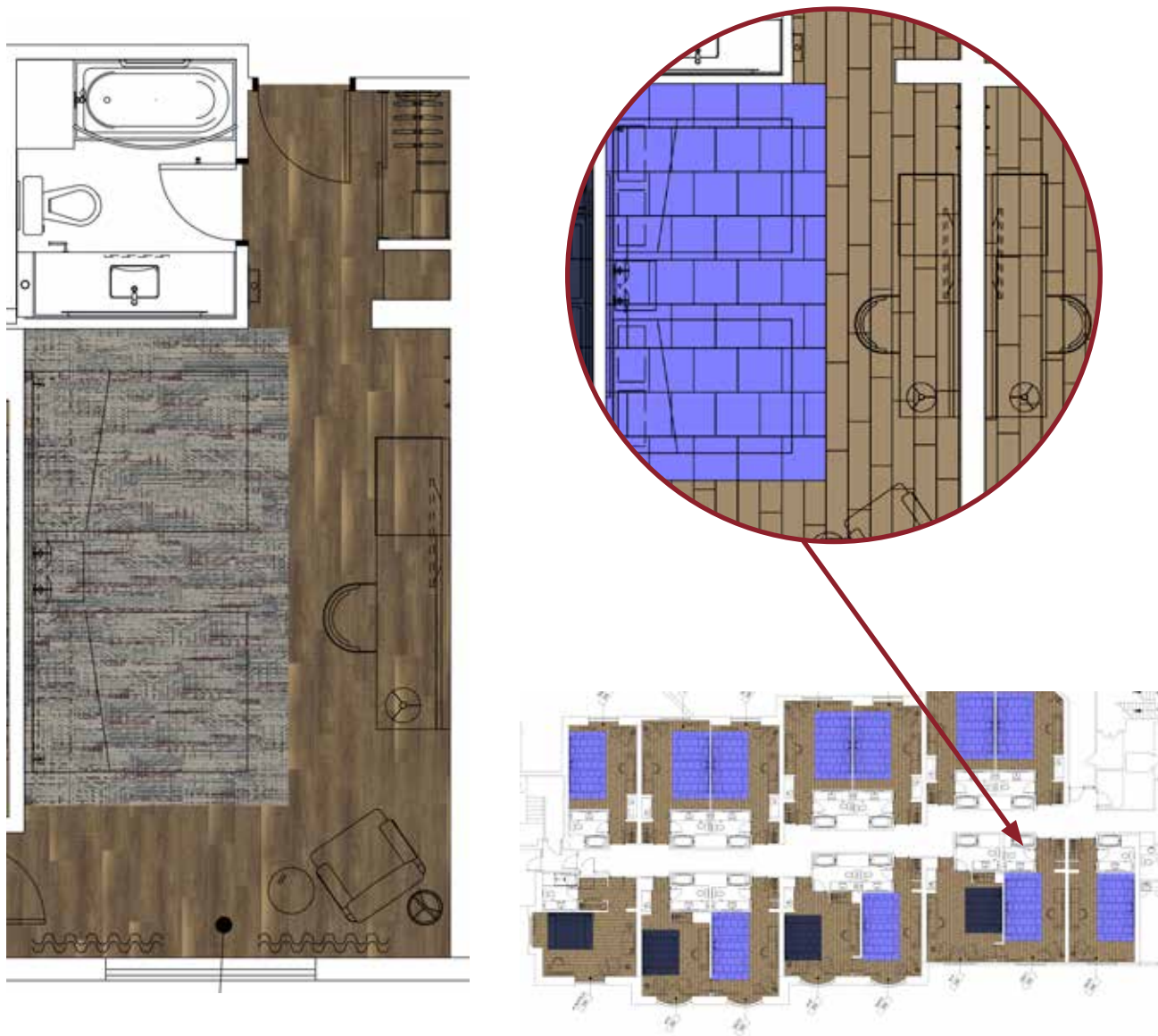

LEGEND

A



B



PRODUCT:
LVT Textured Woodgrains
CONTROL: X-004-DK-OPT
ITEM: 313008
COLOR: A00409
Ash Walnut
SIZE: 25 cm x 1 m
INSTALLED: Ashlar

PRODUCT: Custom
CONTROL: Q-003-OPT-P
ITEM: 326782
COLOR/SAMPLE:
190316_267948-116
SIZE: 50 cm x 50 cm
INSTALLED: Ashlar

Interface®

ELEMENT



APPROVED PROTOTYPES

- Aloft Hotels
- Courtyard
- Delta Hotels
- Element
- Fairfield Inn & Suites
- Four Points
- Marriott Hotels
- Residence Inn
- Sheraton
- TownePlace Suites

ENLIVEN GUESTROOM PROTOTYPE ORDER INFORMATION

Carpet tiles **SAVE APPROXIMATELY 18%-20% IN PRODUCT WASTE** verses broadloom, based on prototype layout.



PRODUCT	KIT#	CONTROL#	ITEM#	COLOR#	SAMPLE#	SIZE	INSTALLATION
A LVT Natural Woodgrains		X-010	277944	A00203 Chesnut		25 cm x 1 m	Ashlar
B RMS102		X-001ALT1	274268	183657	260688-038	50 cm x 50 cm	Brick
Area Rug Kit	98.1110.09	X-005ALT1	274269	183657	260688-038	6'6" X 8'2"	Brick
Area Rug Kit	98.1110.13	X-007ALT1	286295	183657	260688-038	12'6" x 8'6"	Brick

**Scene represents guestroom*

INSTALLATION SPECIFICATIONS	CONTROL#	ITEM#	DESCRIPTION
XL Brands 2000 Plus Adhesive			Double stick install
Selittbloc Underlayment	X-011	276822	Underlayment for entire room with carpet and LVT system

ENLIVEN GUESTROOM INSTALLATION PLAN

All quantities are estimates only and are based on plans provided. Site measurements and field verifications are recommended to ensure accuracy. These quantities are not intended to be used for material ordering purposes. Since waste factors may vary by installer, actual ordering quantities are the responsibility of your flooring contractor.

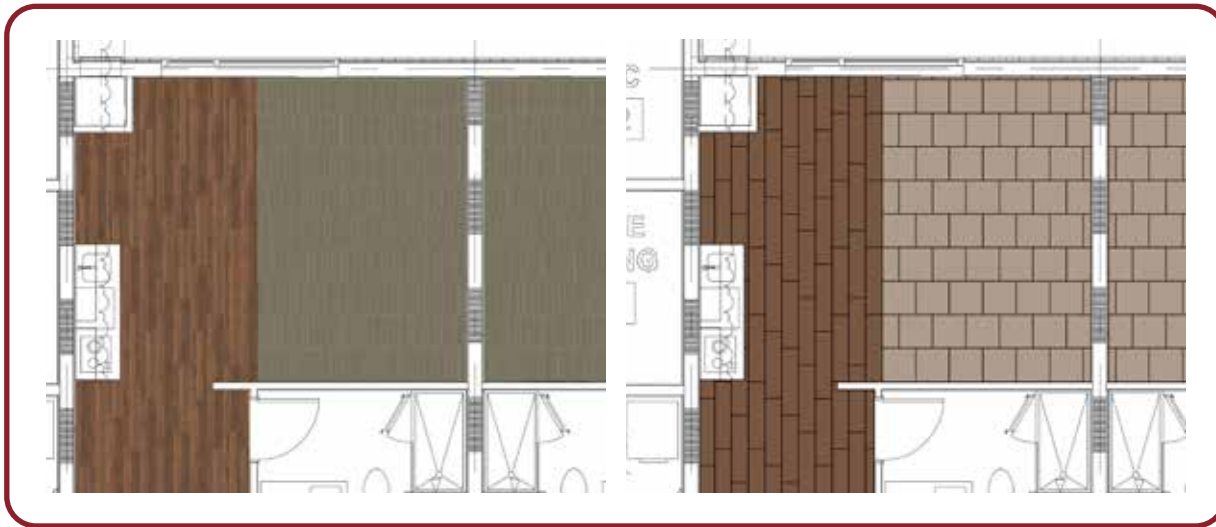

LEGEND

A



PRODUCT: LVT Natural Woodgrains
CONTROL: X-010
ITEM: 277944
COLOR/SAMPLE: A00203 Chesnut
SIZE: 25 cm x 1 m
INSTALLED: Ashlar

B



PRODUCT: RMS102
CONTROL: X-001ALT1
ITEM: 274268
COLOR/SAMPLE: 183657_260688-038
SIZE: 50 cm x 50 cm
INSTALLED: Brick

B



PRODUCT: RMS102
CONTROL: X-005ALT1
ITEM: 274269
COLOR/SAMPLE: 183657_260688-038
SIZE: 50 cm x 50 cm
INSTALLED: Brick

B



PRODUCT: RMS102
CONTROL: X-007ALT1
ITEM: 286295
COLOR/SAMPLE: 183657_260688-038
SIZE: 50 cm x 50 cm
INSTALLED: Brick

ENLIVEN CORRIDOR PROTOTYPE ORDER INFORMATION

Carpet tiles **SAVE APPROXIMATELY 18%-20% IN PRODUCT WASTE** versus broadloom, based on prototype layout.



PRODUCT	CONTROL#	ITEM#	COLOR#	SAMPLE#	SIZE	INSTALLATION
A B603	PG-005ALT1A	296913	188965	267390-055	50 cm x 50 cm	Non Directional
B Custom	PG-005ALT1B	297026	188011	267390-059	50 cm x 50 cm	Pattern by Tile
C Deep Impressions	PG-005ALT1C	297027	188966	267390-058	50 cm x 50 cm	Monolithic

INSTALLATION SPECIFICATIONS	DESCRIPTION
XL2000 PLUS Adhesive	Double stick install

ENLIVEN CORRIDOR INSTALLATION PLAN

All quantities are estimates only and are based on plans provided. Site measurements and field verifications are recommended to ensure accuracy. These quantities are not intended to be used for material ordering purposes. Since waste factors may vary by installer, actual ordering quantities are the responsibility of your flooring contractor.

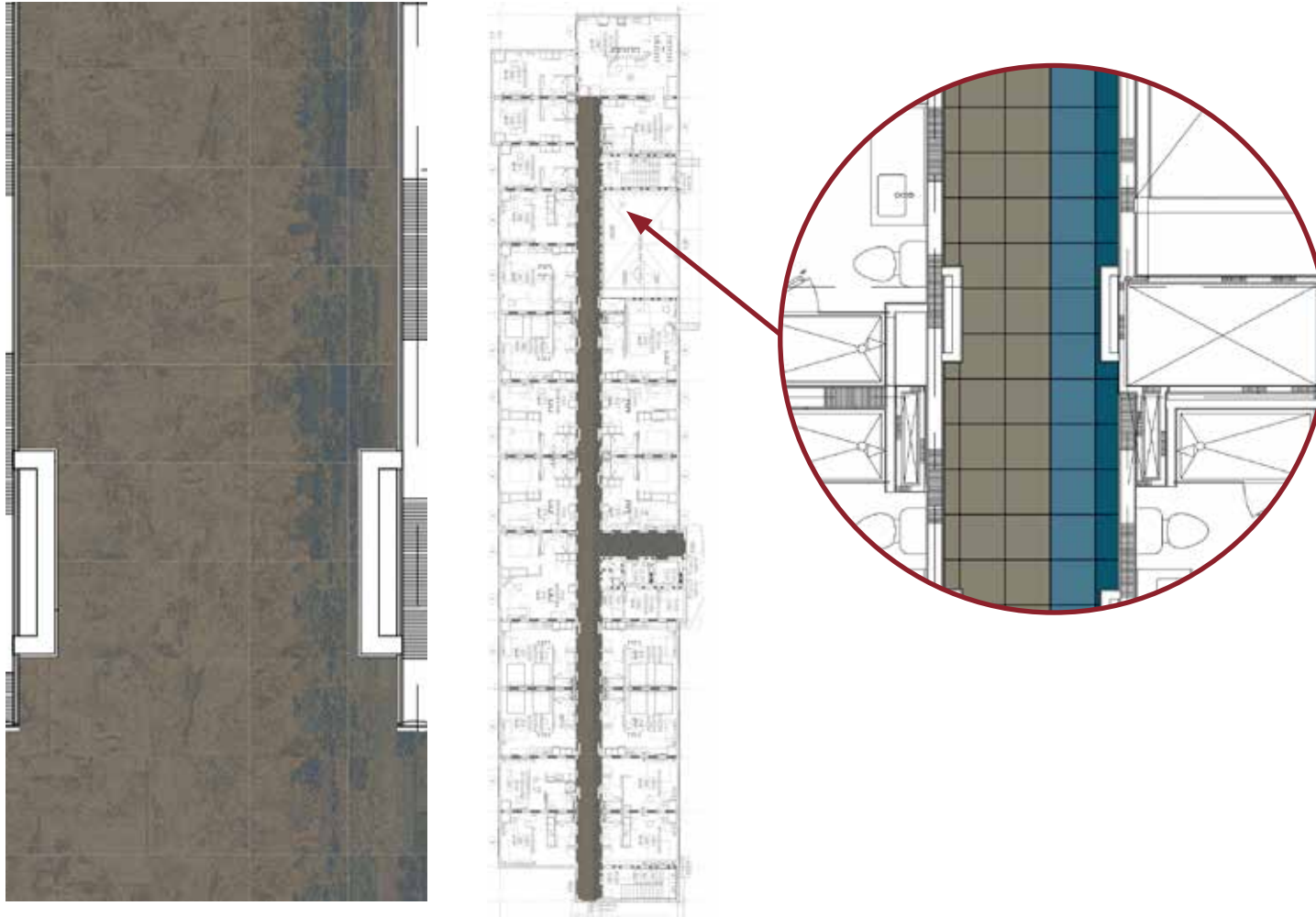

LEGEND

A



PRODUCT: B603
CONTROL: PG-005ALT1A
ITEM: 296913
COLOR/SAMPLE: 188965_267390-055
SIZE: 50 cm x 50 cm
INSTALLED: Non Directional

B



PRODUCT: Custom
CONTROL: PG-005ALT1B
ITEM: 297026
COLOR/SAMPLE: 188011_267390-059
SIZE: 50 cm x 50 cm
INSTALLED: Pattern by Tile

C



PRODUCT: Deep Impressions
CONTROL: PG-005ALT1C
ITEM: 297027
COLOR/SAMPLE: 188966_267390-058
SIZE: 50 cm x 50 cm
INSTALLED: Monolithic

ENLIVEN LOUNGE PROTOTYPE ORDER INFORMATION

Carpet tiles **SAVE APPROXIMATELY 18%-20% IN PRODUCT WASTE** versus broadloom, based on prototype layout.



PRODUCT	CONTROL#	ITEM#	COLOR#	SIZE	INSTALLATION
A HN810	LM-001A	278008	104218 Shale	25 cm x 1 m	Ashlar
B HN840	LM-001B	278013	104226 Shale	25 cm x 1 m	Ashlar
C HN850	LM-001C	278012	104210 Shale	25 cm x 1 m	Ashlar

INSTALLATION SPECIFICATIONS	CONTROL#	ITEM#	DESCRIPTION
XL Brands 2000 Plus Adhesive			Double stick install

ENLIVEN LOUNGE INSTALLATION PLAN

All quantities are estimates only and are based on plans provided. Site measurements and field verifications are recommended to ensure accuracy. These quantities are not intended to be used for material ordering purposes. Since waste factors may vary by installer, actual ordering quantities are the responsibility of your flooring contractor.

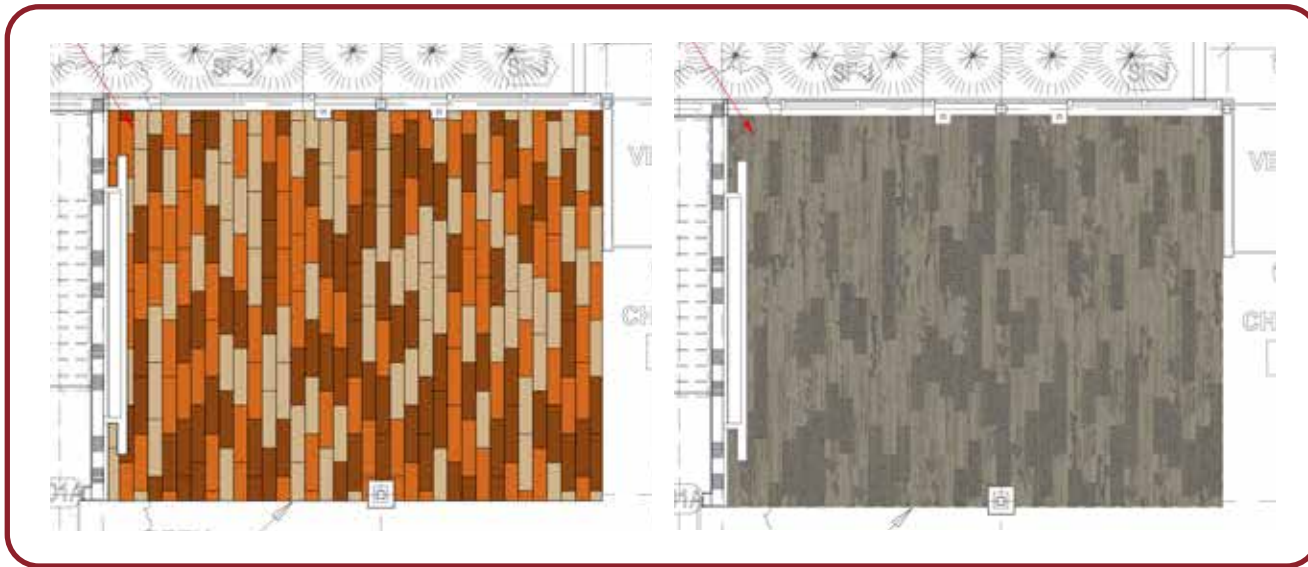

LEGEND

A



PRODUCT: HN810
CONTROL: LM-001A
ITEM: 278008
COLOR: 104218 Shale
SIZE: 25 cm x 1 m
INSTALLED: Ashlar

B



PRODUCT: HN840
CONTROL: LM-001B
ITEM: 278013
COLOR: 104226 Shale
SIZE: 25 cm x 1 m
INSTALLED: Ashlar

C



PRODUCT: HN850
CONTROL: LM-001C
ITEM: 278012
COLOR: 104210 Shale
SIZE: 25 cm x 1 m
INSTALLED: Ashlar

ENLIVEN MEETING ROOM AND ADMIN OFFICES PROTOTYPE ORDER INFORMATION

Carpet tiles **SAVE APPROXIMATELY 18%-20% IN PRODUCT WASTE** versus broadloom, based on prototype layout.



PRODUCT	CONTROL#	ITEM#	COLOR#	SIZE	INSTALLATION
Raw	MR-001 & OA-001	278014	101054 Urban	50 cm x 50 cm	Non Directional

INSTALLATION SPECIFICATIONS	CONTROL#	ITEM#	DESCRIPTION
XL Brands 2000 Plus Adhesive			Double stick install

ENLIVEN MEETING ROOM AND ADMIN OFFICES INSTALLATION PLAN

All quantities are estimates only and are based on plans provided. Site measurements and field verifications are recommended to ensure accuracy. These quantities are not intended to be used for material ordering purposes. Since waste factors may vary by installer, actual ordering quantities are the responsibility of your flooring contractor.

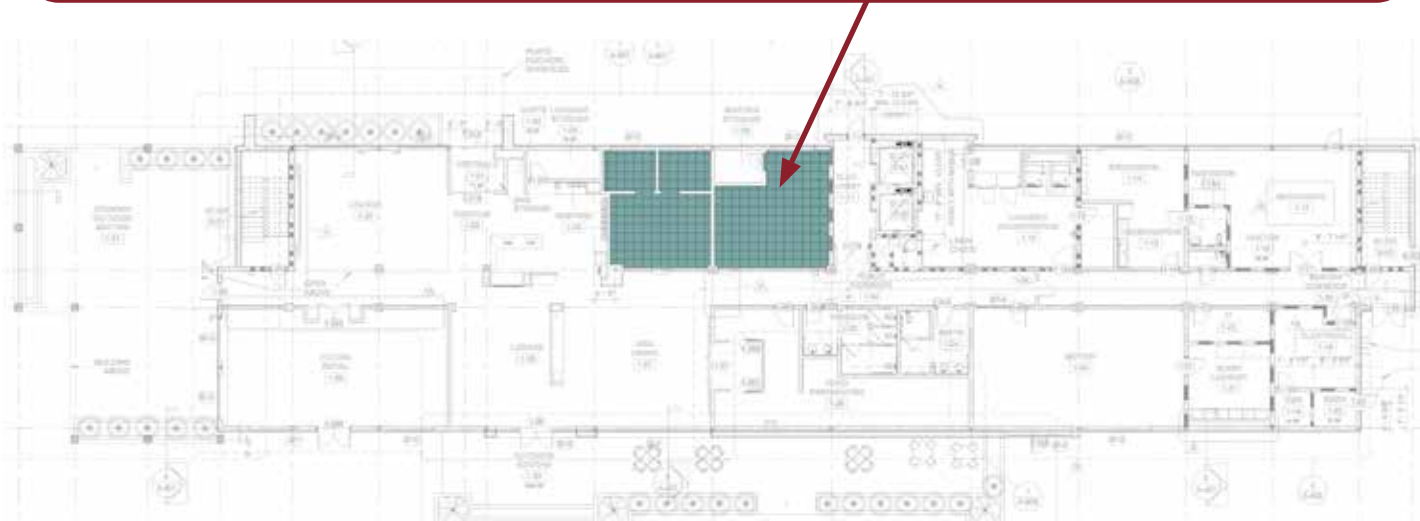
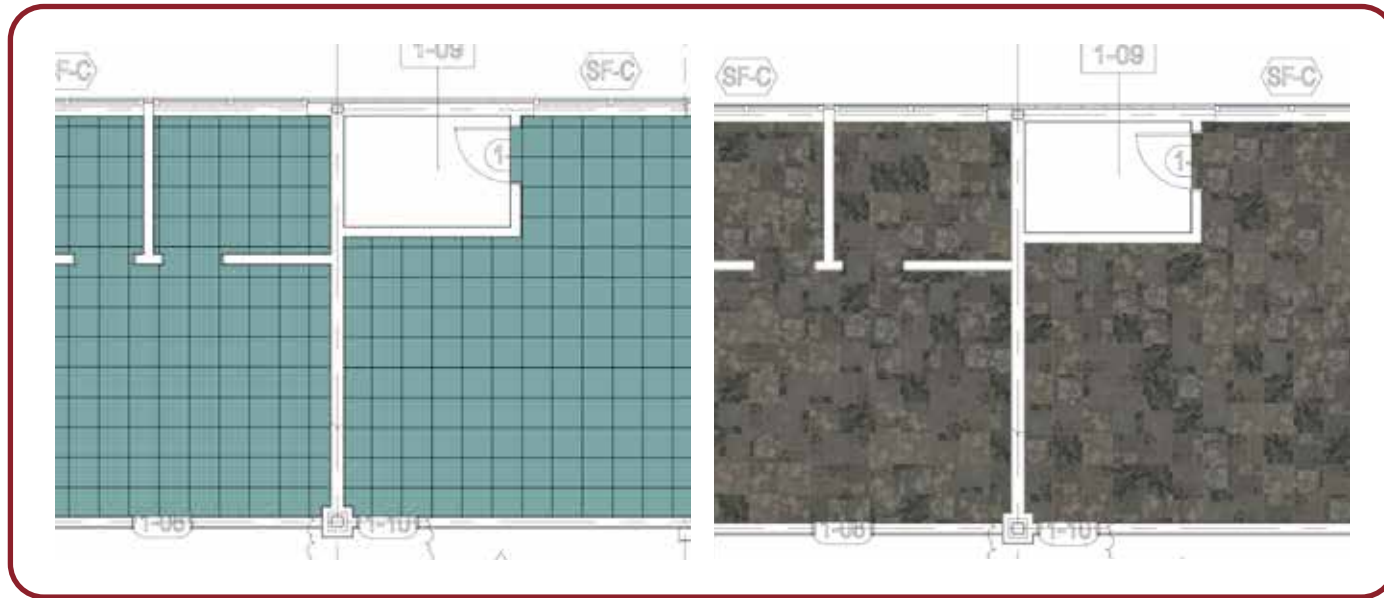

LEGEND

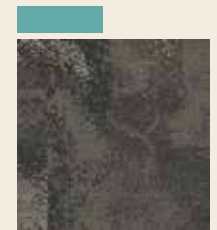

PRODUCT: Raw
CONTROL: MR-001 & QA-001
ITEM: 278014
COLOR: 101054 Urban
SIZE: 50 cm x 50 cm
INSTALLED: Non Directional

Interface®

FAIRFIELD



APPROVED PROTOTYPES

Aloft Hotels
Courtyard
Delta Hotels
Element
Fairfield Inn & Suites
Four Points
Marriott Hotels
Residence Inn
Sheraton
TownePlace Suites

MODERN CALM CORRIDOR PROTOTYPE ORDER INFORMATION

Carpet tiles **SAVE APPROXIMATELY 18%-20% IN PRODUCT WASTE** versus broadloom, based on prototype layout.



PRODUCT	CONTROL#	ITEM#	COLOR#	SAMPLE#	SIZE	INSTALLATION
A Custom	PG-002ALT2C	277374	186558	265389-007	50 cm x 1 m	Ashlar
B Custom	PG-002ALT2B	277371	186559	265389-002	50 cm x 1 m	Ashlar
C Custom	PG-002ALT2A	277373	186560	265389-044	50 cm x 1 m	Pattern By Tile
Monochrome 4" Carpet Base	PG-002BALT2	277370	186561	265389-051	4" x 25' Rolls	

INSTALLATION SPECIFICATIONS	DESCRIPTION
XL2000 PLUS Adhesive	Double stick install

MODERN CALM CORRIDOR INSTALLATION PLAN

All quantities are estimates only and are based on plans provided. Site measurements and field verifications are recommended to ensure accuracy. These quantities are not intended to be used for material ordering purposes. Since waste factors may vary by installer, actual ordering quantities are the responsibility of your flooring contractor.

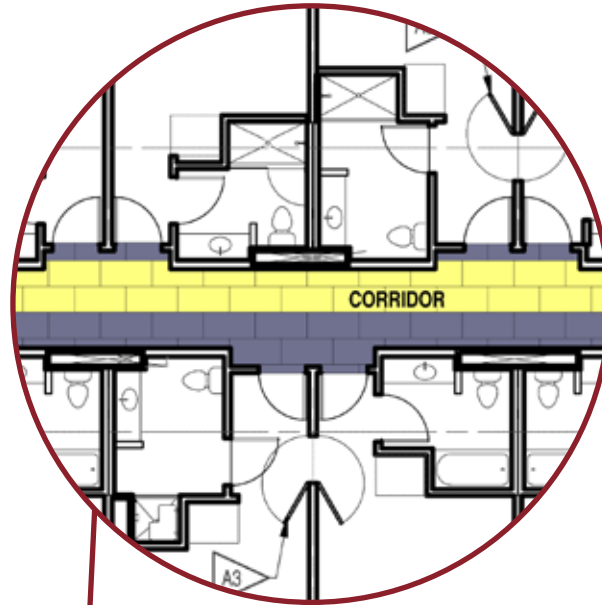
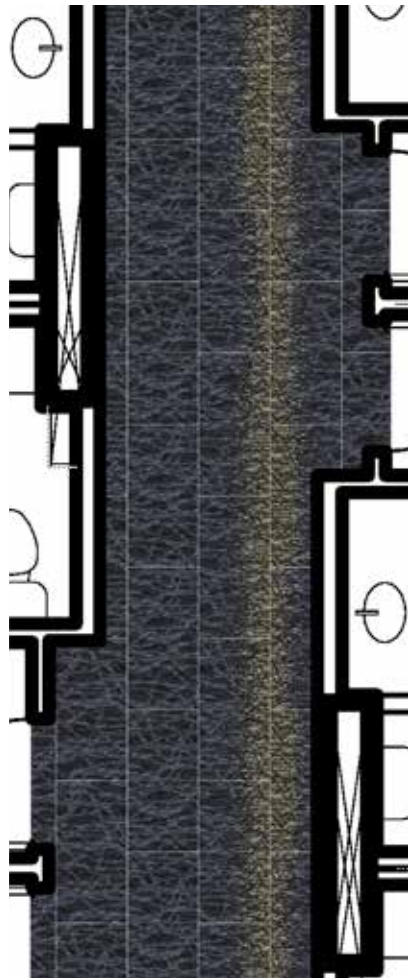

LEGEND

A



PRODUCT: Custom
CONTROL: PG-002ALT2C
ITEM: 277374
COLOR/SAMPLE:
186558_265389-007
SIZE: 50 cm x 1 m
INSTALLED: Ashlar

B



PRODUCT: Custom
CONTROL: PG-002ALT2B
ITEM: 277371
COLOR/SAMPLE:
186559_265389-002
SIZE: 50 cm x 1 m
INSTALLED: Ashlar

C



PRODUCT: Custom
CONTROL: PG-002ALT2A
ITEM: 277373
COLOR/SAMPLE:
186560_265389-044
SIZE: 50 cm x 1 m
INSTALLED: Pattern By Tile

Interface®

FOUR POINTS



APPROVED PROTOTYPES

Aloft Hotels
Courtyard
Delta Hotels
Element
Fairfield Inn & Suites
Four Points
Marriott Hotels
Residence Inn
Sheraton
TownePlace Suites

VINTAGE MODERN CORRIDOR PROTOTYPE ORDER INFORMATION

Carpet tiles **SAVE APPROXIMATELY 18%-20% IN PRODUCT WASTE** versus broadloom, based on prototype layout.



PRODUCT	CONTROL#	ITEM#	COLOR#	SIZE	INSTALLATION
A Harmonize	PG-001ALT2A	275327	104041 Iceberg	25 cm x 1 m	Herringbone
B Harmonize	PG-001ALT2B	283444	104043 Gravel	25 cm x 1 m	Herringbone
C Harmonize	PG-001ALT2C	283445	104044 Pewter	25 cm x 1 m	Herringbone

INSTALLATION SPECIFICATIONS	DESCRIPTION
XL2000 PLUS Adhesive	Double stick install

VINTAGE MODERN CORRIDOR INSTALLATION PLAN

All quantities are estimates only and are based on plans provided. Site measurements and field verifications are recommended to ensure accuracy. These quantities are not intended to be used for material ordering purposes. Since waste factors may vary by installer, actual ordering quantities are the responsibility of your flooring contractor.

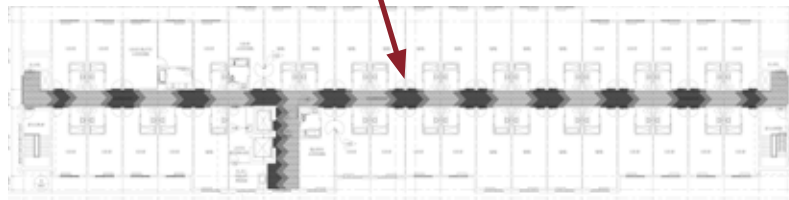
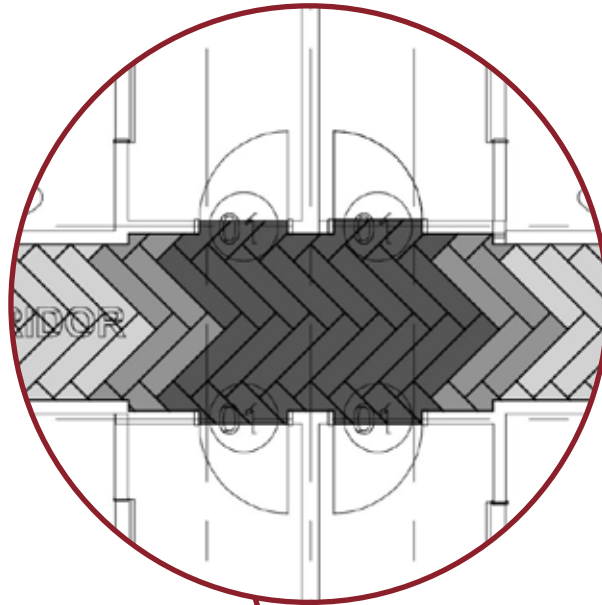

LEGEND

A



PRODUCT: Harmonize
CONTROL: PG-001ALT2A
ITEM: 275327
COLOR: 104041 Iceberg
SIZE: 25 cm x 1 m
INSTALLED: Herringbone

B



PRODUCT: Harmonize
CONTROL: PG-001ALT2B
ITEM: 283444
COLOR: 104043 Gravel
SIZE: 25 cm x 1 m
INSTALLED: Herringbone

C



PRODUCT: Harmonize
CONTROL: PG-001ALT2C
ITEM: 283445
COLOR: 104044 Pewter
SIZE: 25 cm x 1 m
INSTALLED: Herringbone

VINTAGE MODERN GUESTROOM PROTOTYPE ORDER INFORMATION

Carpet tiles **SAVE APPROXIMATELY 18%-20% IN PRODUCT WASTE** versus broadloom, based on prototype layout.



PRODUCT	KIT#	CONTROL#	ITEM#	COLOR#	SAMPLE#	SIZE	INSTALLATION
A LVT Natural Woodgrains		RF-100-ALT2	283403	A00212 Cedar		25 cm x 1 m	Ashlar
B Asteria		X-001ALT3	274963	186254	263115-037	50 cm x 50 cm	Non Directional
Area Rug Kit	98.1110.10	X-001ALT3K	284388	186254	263115-037	9'10" x 8'2"	Non Directional
Area Rug Kit	98.1110.11	X-001ALT3AQ	284390	186254	263115-037	14'9" x 8'2"	Non Directional
Area Rug Kit	98.1110.12	X-001ALT3Q	284389	186254	263115-037	14'9" x 8'2"	Non Directional

**Scene represents QQ guestroom.*

INSTALLATION SPECIFICATIONS	CONTROL#	ITEM#	DESCRIPTION
XL Brands 2000 Plus Adhesive			Double stick install
Selittbloc Underlayment	RF-100X-ALT2	276822	Underlayment for entire room with carpet and LVT system

VINTAGE MODERN GUESTROOM INSTALLATION PLAN

All quantities are estimates only and are based on plans provided. Site measurements and field verifications are recommended to ensure accuracy. These quantities are not intended to be used for material ordering purposes. Since waste factors may vary by installer, actual ordering quantities are the responsibility of your flooring contractor.

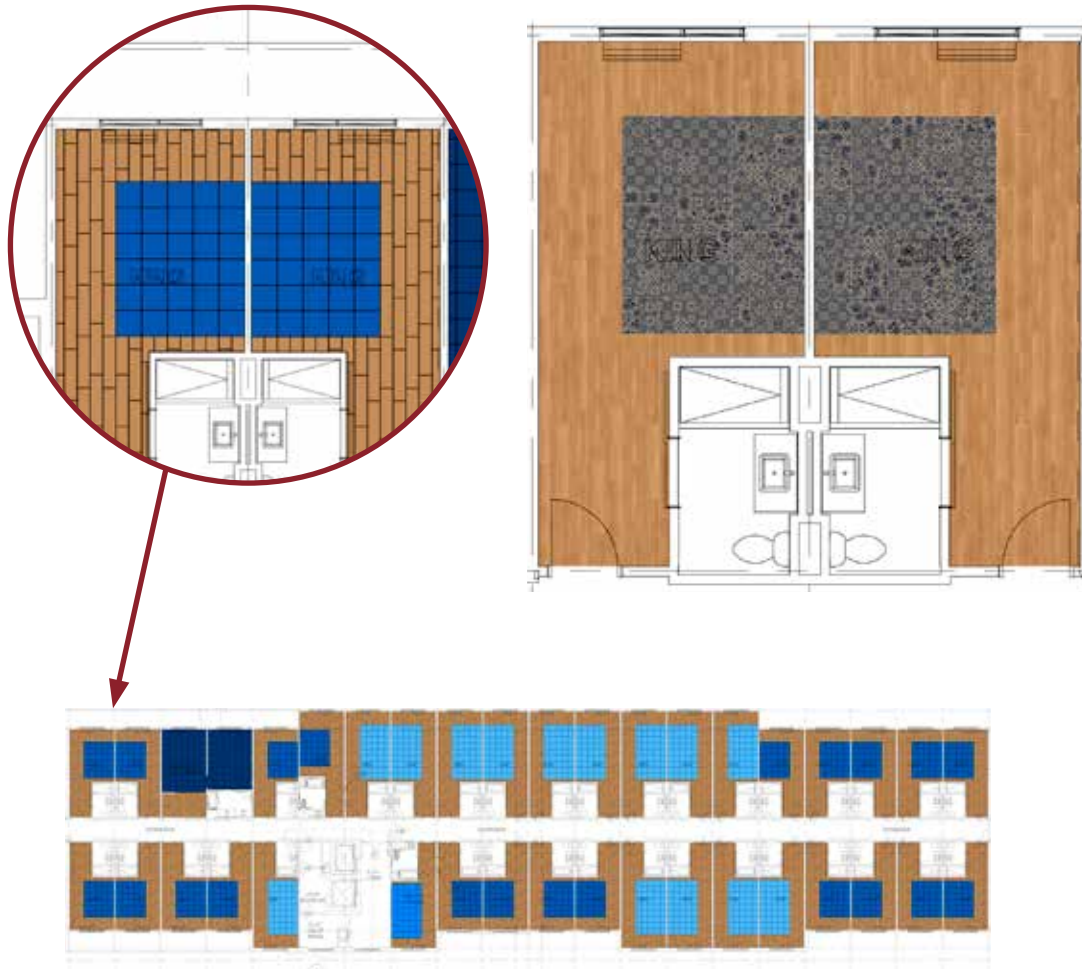

LEGEND

A



PRODUCT: LVT Natural Woodgrains
CONTROL: RF-100-ALT2
ITEM: 283403
COLOR: A00212 Cedar
SIZE: 25 cm x 1 m
INSTALLED: Ashlar

B

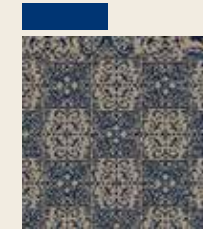

PRODUCT: Asteria
CONTROL: X-001ALT3
ITEM: 274963
COLOR/SAMPLE: 186254_263115-037
SIZE: 50 cm x 50 cm
INSTALLED: Non Directional

B

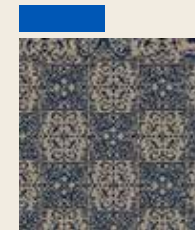

PRODUCT: Asteria
CONTROL: X-001ALT3K
ITEM: 284388
COLOR/SAMPLE: 186254_263115-037
SIZE: 50 cm x 50 cm
INSTALLED: Non Directional

B

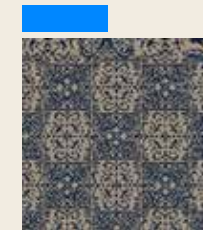

PRODUCT: Asteria
CONTROL: X-001ALT3AQ
ITEM: 284390
COLOR/SAMPLE: 186254_263115-037
SIZE: 50 cm x 50 cm
INSTALLED: Non Directional

B

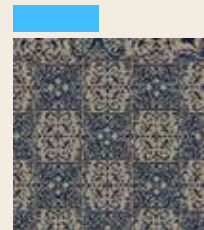

PRODUCT: Asteria
CONTROL: X-001ALT3Q
ITEM: 284389
COLOR/SAMPLE: 186254_263115-037
SIZE: 50 cm x 50 cm
INSTALLED: Non Directional

Interface®

RESIDENCE INN



APPROVED PROTOTYPES

Aloft Hotels
Courtyard
Delta Hotels
Element
Fairfield Inn & Suites
Four Points
Marriott Hotels
Residence Inn
Sheraton
TownePlace Suites

NEUHAUS – HONED & WEAVE CORRIDOR PROTOTYPE ORDER INFORMATION

Carpet tiles **SAVE APPROXIMATELY 18%-20% IN PRODUCT WASTE** versus broadloom, based on prototype layout.



PRODUCT	CONTROL#	ITEM#	COLOR#	SAMPLE#	SIZE	INSTALLATION
A Custom	PG-011B	281762	187033	256387-182	25 cm x 1 m	Ashlar
B Custom	PG-011A	290142	187224	256387-193	25 cm x 1 m	Ashlar
C Custom	PG-011C	290143	187225	256387-195	25 cm x 1 m	Ashlar
Monochrome 4" Carpet Base	PG-011D	281756	101800 Umber		4" x 25' Rolls	

INSTALLATION SPECIFICATIONS	DESCRIPTION
XL2000 PLUS Adhesive	Double stick install

NEUHAUS – HONED & WEAVE CORRIDOR INSTALLATION PLAN

All quantities are estimates only and are based on plans provided. Site measurements and field verifications are recommended to ensure accuracy. These quantities are not intended to be used for material ordering purposes. Since waste factors may vary by installer, actual ordering quantities are the responsibility of your flooring contractor.

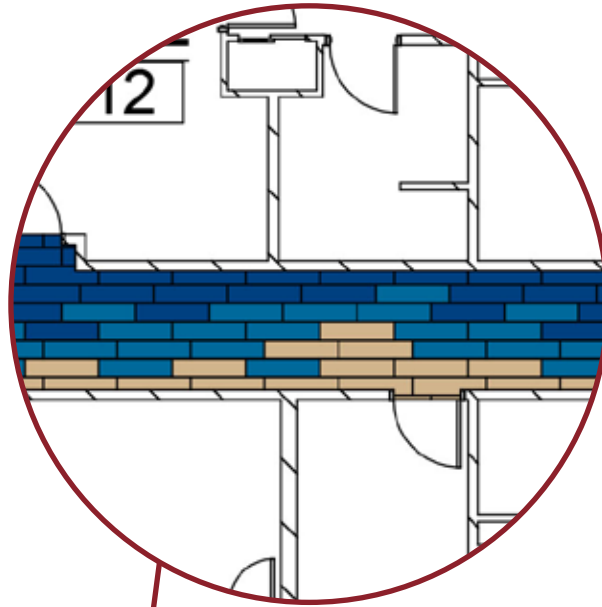

LEGEND

A



PRODUCT: Custom
CONTROL: PG-011B
ITEM: 281762
COLOR/SAMPLE:
 187033_256387-182
SIZE: 25 cm x 1 m
INSTALLED: Ashlar

B



PRODUCT: Custom
CONTROL: PG-011A
ITEM: 290142
COLOR/SAMPLE:
 187224_256387-193
SIZE: 25 cm x 1 m
INSTALLED: Ashlar

C

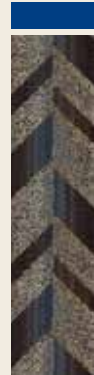

PRODUCT: Custom
CONTROL: PG-011C
ITEM: 290143
COLOR/SAMPLE:
 187225_256387-195
SIZE: 25 cm x 1 m
INSTALLED: Ashlar

Interface®

TOWNEPLACE SUITES



APPROVED PROTOTYPES

Aloft Hotels
Courtyard
Delta Hotels
Element
Fairfield Inn & Suites
Four Points
Marriott Hotels
Residence Inn
Sheraton
TownePlace Suites

REAL LIVING GUESTROOM PROTOTYPE ORDER INFORMATION

Carpet tiles **SAVE APPROXIMATELY 18%-20% IN PRODUCT WASTE** verses broadloom, based on prototype layout.



PRODUCT	CONTROL#	ITEM#	COLOR#	SAMPLE#	SIZE	INSTALLATION
A Custom	X-001OPT3	303769	188538	267341-053	50 cm x 50 cm	Monolithic
B LVT Textured Woodgrains	X-010OPT2	282981	A00406 Antique Light Oak		25 cm x 1 m	Ashlar
Monochrome 4" Carpet Base	X-005OPT3	303773	101837 Granite		4" x 25' Rolls	

INSTALLATION SPECIFICATIONS	CONTROL#	ITEM#	DESCRIPTION
XL2000 PLUS Adhesive			Double stick install
Selitbloc Underlayment	X-010AOPT2	276822	Underlayment for entire room with carpet and LVT system

REAL LIVING GUESTROOM INSTALLATION PLAN

All quantities are estimates only and are based on plans provided. Site measurements and field verifications are recommended to ensure accuracy. These quantities are not intended to be used for material ordering purposes. Since waste factors may vary by installer, actual ordering quantities are the responsibility of your flooring contractor.

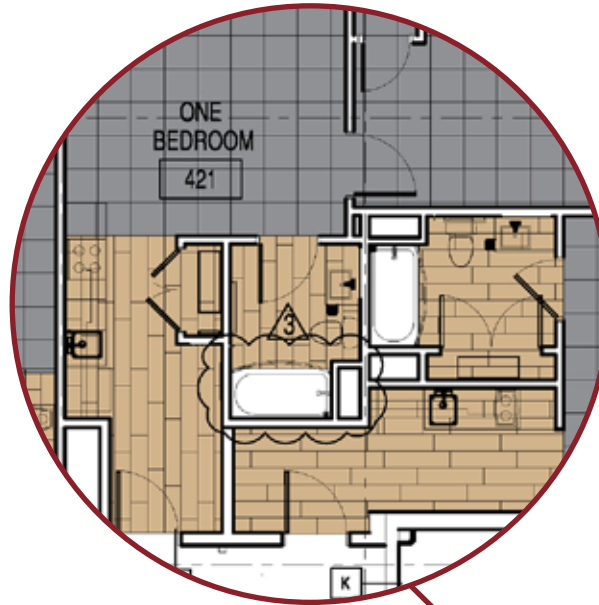
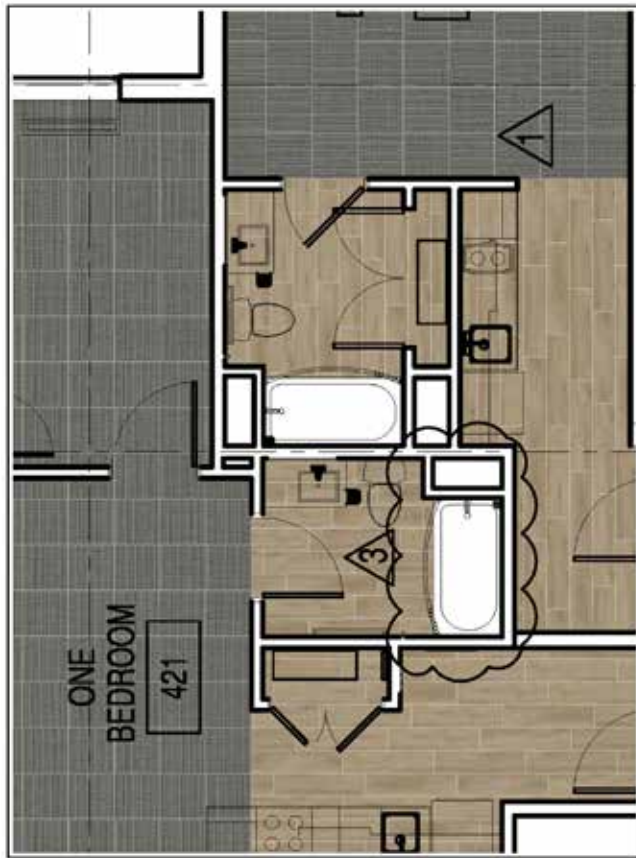

LEGEND

A



PRODUCT: Custom
CONTROL: X-001OPT3
ITEM: 303769
COLOR/SAMPLE:
188538_267341-053
SIZE: 50 cm x 50 cm
INSTALLED: Monolithic

B



PRODUCT: LVT Textured
Woodgrains
CONTROL: X-010OPT2
ITEM: 282981
COLOR: A00406
Antique Light Oak
SIZE: 25 cm x 1 m
INSTALLED: Ashlar